



PHILADELPHIA GAS WORKS

FIELD SERVICES DEPARTMENT

PIPING SPECIFICATIONS

&

EQUIPMENT INSTALLATIONS

January 2010

Contents

		PAGE		PAGE
Section 1	General	7	Section 10	Manifolding of Vents
				Manifold sizing formula
1.0	Turn On of Gas	7		
1.1	Piping Plan	7	Section 11	Termination of Regulator
1.2	Piping Sizing	7-8		
1.3	Pressure Limitations/Welded Pipe	8	Section 12	Combustion Air and Venting
1.4	Exposed Piping	8-9	12.1	Air for combustion
1.5	Drips	9-10	12.2	Equipment requiring venting
1.6	Vertical Risers	10	12.3	Minimum standard volume
1.7	Sediment Traps	10		
			Section 13	Gas Vents – More Than One Floor
			13.1	Category 1 equipment
Section 2	Piping Materials	11	13.2	Connected to the common vent
2.0	Black Iron Pipe	11		
2.1	Corrugated Stainless Steel Tubing (CSST)	12	Section 14	Contaminated Air
2.2	Metallic Fittings	12		
2.3	Shut Off Valves and Unions	12	Section 15	Emergency Gas Generators
			15.0	Installation
Section 3	Piping Installations	15	15.1	Philadelphia Fire Code
3.1	Tunnel	15	15.2	PGW Policy
3.2	Trench	15		
3.3	Crawl Space	16	Section 16	Chimney Used to Vent Cat. 1 Equip.
3.4	Piping Embedded in Concrete	16	16.1	Venting appliance
3.5	Prohibited Location for Piping	16-17	16.2	Masonry Chimneys
3.6	Pipe Penetration	17	16.3	Chimney Previously Used for Oil
			16.4	Chimney Passageway
			16.5	Cleanouts
Section 4	Underground Gas Piping	18		
4.0	Scope of Specifications	18	Section 17	Category II, III, and IV Gas Equipment
4.1	Authority to Install	18		
4.2	Inspection	18	Section 18	Booster Pump Installation
			Section 19	Commercial and Industrial Turn On
Section 5	Above Ground Piping Outside	19		
5.1	Pipe Specifications	19	Section 20	Flexible Connectors on Appliances
5.2	Valves (All Types of Pipe)	19		
5.3	Installation of Piping	19-20	Exhibit A	Bollards
Section 6	Copper Tubing Specifications	21	Exhibit B	Low Pressure 3 Meter Installation
6.1	Copper Tubing Guidelines	21	Exhibit C	Quick Disconnect – Movable Appliance
	Copper Capacity Table	21	Exhibit D	Moveable Appliance Connection
			Exhibit E	Drip
Section 7	Pressure Testing	22	Exhibit F	Booster
7.1	Pressure Test Gauges	23	Exhibit G	Diversity Factor
7.2	Pressure Test Requirements	23-24		
			Supplement	CSST
Section 8	Meter Location	25	Supplement	Ventilation and Combustion Air
8.1	Meter Location	25		
8.2	Separate Building	25	Checklist	Commercial & Industrial Installations
8.3	Specifications	25-26		
8.4	Drawings	26	Checklist	Residential Installations
8.5	Installation & Maintenance	26		
				Notes
Section 9	Venting of Regulators	27		
			Photos	Gas Piping Drips
				Installed Bollards
				Various Outside Sets
				Manifolded Vents On Industrial Boiler
				Booster Installation

RW/jk
1/10

The Gas Main and Service Installation Process

Steps to Simplify Service Line Installation

Step 1

If you need to have a gas service installed, please call the phone number listed below that best describes your type of property. A Marketing Representative will be assigned to your project and will work with you throughout the process.

This process can take a minimum of 4–12 weeks depending on the type and extent of the project such as:

- Gas Main and Service Installed
- Separation of Service
- Relocation of Service

Other circumstances that can influence installations are:

- Time of Year
- Gas Main and Service Availability
- Securing City Permits
- Weather Conditions
- Customer Response Time

Residential Properties: (215) 684-6730

Small Commercial Properties: (215) 684-6740

Large Tract Residential Builders Properties: (215) 684-6701

Large Commercial/Industrial-Major Accounts Properties: (215) 684-6671

Step 2

The following information is required to expedite all projects:

The builder, contractor, or customer's name, the address where service is being requested, the mailing address and the daytime telephone.

A list of all new and existing gas appliances with corresponding load input information (BTU/hr).

Required minimum gas delivery pressure for the equipment.

Approved site/construction plans and project timeline.

Completed Tax Exemption Form (if applicable).
A gas service application completed by the builder, contractor or customer responsible for initially requesting gas service.

- Residential Application
Gas House Heating Application
- Commercial and Industrial Application
Entity formation documents filed with the Commonwealth of Pennsylvania

Additional items that may be required includes:

- Drawing of internal fuel lines if requesting total connected load of 1400 CFH or 2 PSI of delivery pressure or greater
- Proof of Community Development Corporation (CDC) sponsorship
- Acceptable security (i.e., letter of credit)
- Executed contract

Step 3

The Marketing Representative will process your service request to determine the correct size, the outside meter location and any upfront costs involved with the installation of your new gas service.

All contractual obligations between Philadelphia Gas Works and the customer must be fulfilled prior to beginning the Gas Service Installation Process.

All residential and commercial application forms, piping specifications and equipment installation requirements may be obtained from your Marketing Representative or online at PGW's website (www.pgworks.com, click on the Gas Service request tab).

In Pennsylvania, you are required to contact PA One Call by dialing 8-1-1, at least three business days before beginning any digging or excavation project.

Know what's below.

For more information – visit www.paonecall.org

**Philadelphia Gas Works
Marketing Department
800 W. Montgomery Avenue
Philadelphia, PA 19122**

Ready...Set...Turn-on

Are you ready to have the meter installed and turned on?

When the Gas Main and Service Installation is complete, your Marketing Representative will meet with you to determine if your property or project is ready to have the gas turned on. To assist you in expediting this process, a convenient check list has been compiled.

Initial Requirements

- All gas equipment input information (BTU/hr) must be verified.
- All gas equipment whose input information was verified must be installed.
- The appliance minimum delivery pressure must be verified.
- A gas service application and credit check must be completed.
- Any unpaid bill or deposit must be paid (if applicable).

Piping Specifications

- All piping must be installed per applicable piping codes. International Fuel Gas Code (most current edition) is the standard for the installation of fuel gas piping and equipment. NFPA National Fuel Gas Code (most current edition) is the standard for any issues not addressed in the International Fuel Gas Code. A supplemental manual developed by PGW which further defines installation specifications is also available on PGW's website by accessing www.pgworks.com.
- Corrugated stainless steel tubing (CSST) or flex tubing must be installed according to manufacturers' specifications.
- Fuel lines must be sleeved through all exterior wall penetrations.
- No bushings are permitted in the fuel line.
- All black iron pipe exposed to outside elements must be painted. (and be maintained in the future).
- Drip legs are required at the vertical riser closest to the meter or any section of fuel line that is trapped.
- Fuel lines must be clearly marked on all multiple meter sets.
- Fuel lines must pass a 3 LB. pressure test (if applicable).
- All appliances must be installed and ready
- Commercial and Industrial Accounts must have all equipment installed before gas can be turned on.

811

Know What's Below - Call Before You Dig

www.paonecall.org

Equipment Specifications

- All heating units must be piped and vented according to manufacturers' specifications.
- All forced air furnaces require circulating air to be conducted into the blower housing from outside the furnace enclosure by continuous air-tight ducts.
- All automatic water heaters must be piped and vented.
- If your gas appliances are located in a confined space, provisions must be made to introduce the proper amount of additional combustion, ventilation and dilution air to the space.
- Chimney cleanouts are required in all masonry and "B" vent chimneys.
- Chimney liner must be installed and the chimney should be clean and free of any debris.
- Fireplaces must be piped and vented (if applicable).
- A gas shut-off valve must be installed within six (6) feet of each appliance casing.
- A working thermostat must be installed.

Additional Requirements

- The gas curb box must be visible and accessible.
- In some cases, bollards will need to be installed to protect the meter set.
- Permanent electric must be installed.

The Marketing Representative assigned to your project can answer any questions you may have pertaining to this process. It is important that you refer to this checklist before you call to schedule an appointment for a meter installation and service turn-on.

[Adhering to this checklist will assist in keeping your project on schedule and save additional costs to the gas service turn-on process.](#)

Scope

The International Fuel Gas Code ~ is the standard for the installation of fuel gas piping and equipment. The National Fuel Gas Code is the standard for any issues not addressed in the International Fuel Gas Code. The attached specifications are a PGW supplement to both Fuel Gas Codes. In some cases these specifications differ from the standards. The difference exists due to experience based on local conditions and is intended to further ensure that the customer will be provided with a safe and efficient installation in order to properly and safely operate their gas utilization equipment. The specifications are subject to revisions as conditions change and supersede specifications dated October, 2007

SECTION 1 GENERAL

1.0 Turn On of Gas

PGW reserves the right to refuse to turn on gas into a piping system not installed in accordance with these specifications. Every effort must be made by the contractor to have all gas utilization equipment installed and ready before gas is turned on. PGW will not turn-on gas to only one piece of gas equipment (e.g. generator, AWH, etc.,) unless approved by a Field Services General Superintendent.

1.1 Piping Plan

Before installing gas piping, a piping plan and other necessary drawings listing all appliance consumptions and other data, e.g. appliance minimum pressure requirement, and outlet pressure required at meter if other than low pressure, should be submitted to the Marketing Department, 800 West Montgomery Avenue, 3rd Floor for approval. If piping cannot be installed in accordance with these specifications, contact the Field Services Department, Industrial/Commercial and Large Meter Group at 215-787-5130 for additional information and approval for each individual case.

1.2 Piping Sizing

Schedule 40 Metallic Pipe

Inlet pressure: less than 2 psi

Pressure Drop: .3" w. c.

Pipe Size (in.)

Nominal	1/2	3/4	1	1 1/4	1 1/2	2	2 1/2	3	4	6	8
---------	-----	-----	---	-------	-------	---	-------	---	---	---	---

Maximum Capacity in Cubic Feet of Gas Per Hour											
Length (ft)											
10	131	273	514	1060	1580	3050	4860	8580	17500	51300	105000
20	90	188	353	726	1090	2090	3340	5900	12000	35300	72400
30	72	151	284	583	873	1680	2680	4740	9660	28300	58200
40	62	129	243	499	747	1440	2290	4050	8270	24200	49800
50	55	114	215	442	662	1280	2030	3590	7330	21500	44100
60	50	104	195	400	600	1160	1840	3260	6640	19500	40000
70	46	95	179	368	552	1060	1690	3000	6110	17900	36800
80	42	89	167	343	514	989	1580	2790	5680	16700	34200
90	40	83	157	322	482	928	1480	2610	5330	15600	32100
100	38	79	148	304	455	877	1400	2470	5040	14800	30300
125	33	70	131	269	403	777	1240	2190	4460	13100	26900
150	30	63	119	244	366	704	1120	1980	4050	11900	24300
175	28	58	109	224	336	648	1030	1820	3720	10900	22400
200	26	54	102	209	313	602	960	1700	3460	10100	20800

IFGC Table 402.4(1)

Note: For Higher Pressures and Larger sizes refer to IFGC-2009

SECTION 1 GENERAL

- 1.2.1 All piping must be sized to provide proper appliance utilization pressure at the appliance's rated consumption (IFGC (most current edition) for Pipe Size Calculation Procedures).
- 1.2.2 Low-pressure piping up to 14" W.C. (.5 psig) shall be sized to allow for a total piping system pressure drop of 0.3 inch W.C. pressure.
- 1.2.3 Piping utilizing pressures above 14" W.C. should be sized for a 10% pressure drop. Piping carrying gas at any pressure above 14" W.C. must be clearly marked at intervals of 10 feet to indicate "High Pressure Natural Gas".
- 1.2.4 Diversity factor for multiple dwelling units – the common gas supply line to multiple family units may be sized for a percentage of the total gas demand. The total gas demand for each common section of pipe shall be sized in accordance with the multiplier found in "Exhibit G – Diversity Factors". (Add page no.)

1.3 Pressure Limitations and Welded Pipe

- 1.3.1 Systems utilizing screw pipe must meet both conditions below:
 - a) **Low pressure gas being delivered at 14"W.C. or below**
 - b) **Pipe size 4" and below**
- 1.3.2 Welded fuel line is required if **any** one of the following is present:
 - a) pressure above 14" W.C.
 - b) fuel line larger than 4"
- 1.3.3 The maximum operating pressure allowed inside a building shall not exceed 5 psig. Any exceptions will need a PGW Field Operations **Director or higher** to review and provide written approval for inside pipe systems requiring pressures above 5 psig.
- 1.3.4 Delivery pressure above 2 lbs in customer fuel lines will need an over protection device on all low pressure equipment (ANSI Z21.80)

1.4 Exposed Piping

- 1.4.1 All piping is to be installed in an exposed area whenever possible. In cases where the fuel line will extend through an outside or foundation wall, permanent concrete ceiling, and/or cinder block floor or roof, the piping shall be protected against damage and corrosion by encasing the pipe in a protective pipe sleeve. The annular space between the gas piping and the sleeve must be sealed. This prevents the entry of water, insects, or rodents and serves as a fire stop. P.V.C. is

the preferred material for pipe sleeves. Flue pipe is acceptable, as long as it is installed with an air space around the entire circumference of the carrier pipe and all seams are sealed. The annular space between the gas piping and sleeve must also be sealed.

1.4.2 Pipe exposed to the weather must be properly sized. Galvanized pipe or protectively coated wrought iron or painted steel pipe shall be used.

1.4.3 A gas shut-off valve and union must be installed within six (6) feet of the appliance casing but not within the casing unless packaged with the unit. In this case, we will require a shut-off valve be installed outside the casing. The tubing for pilot(s) must be within the unit casing to prevent freezing.

1.5 **Drips**

A drip shall be provided at any point in the line of pipe where condensation may collect, and for winter use, weatherproofed to prevent freezing. (See Table 1 for minimum sizes.) The drip must be accessible. (See Exhibit E, Page 51.)

F:\Share\FOPWG\TR and REVISED BULLETINS and PROCEDURES\2009\TR-2009-37\TR 2009-37 Final Version Drips must be installed as follows:

- a. Any point where condensation may collect (hot to cold location or vice versa).
- b. At riser closet to gas meter
- c. At supervisors direction
- d. At appliance (Sediment Trap)
- e. As described in Section 1.5 through 1.7 of this manual

Over 14" W.C. and/or Over 4" Dia.



14" W.C. and 4" Dia. or less



Table 1	
<u>Pipe Size (Diameter)</u>	<u>Drip Size (Diameter)</u>
Under 3/4"	Full Size
3/4" to 1"	3/4"
2"	1"
3"	1-1/2" or 3"
4"	2" or 4"

In addition, if pressure in the fuel line where the drip is located is greater than 14" W.C., a shut off valve must be provided on the drip.

1.6 Vertical Risers

A drip will only be required at the vertical riser closest to the meter. All other risers from this point will not require a drip unless the pipe passes from a cold to hot location (or hot to cold). The minimum drip size is shown on Table 1. The minimum length of the drip leg shall be three (3") inches without including the shut-off valve.

1.7 Sediment Traps (IFGC, (most current edition) ~408.4)

Where a sediment trap is not incorporated as part of the gas utilization equipment, a sediment trap shall be installed downstream of the equipment shutoff valve as close to the inlet as practical. The sediment trap shall be either a tee fitting with a capped nipple in the bottom opening of the run of the tee or other device approved as an effective sediment trap. Illuminating appliances, ranges, clothes dryers and outdoor grills need not be so equipped.

SECTION 2 PIPING MATERIALS

2.0 Black Iron Pipe

Steel and wrought iron pipe shall be at least schedule 40. Cast iron and ductile iron pipe are not permitted in fuel line (See Sections 4.0 and 5.0 for the use of underground plastic and copper fuel lines.)

- 2.0.1** Gas piping shall be installed so as to prevent strains and stresses, which will exceed the structural strength of the pipe. Provisions shall be made for expansion and contraction and for structural settlement that may affect the piping. Bushings are not permitted for use in any gas fuel line.

Support of Piping (IFGC, (most current edition) ~Page 75-415.1)

Steel Pipe, Nominal Size of Pipe (Inches)	Spacing of Supports (Feet)	Tubing Smooth-Wall (in. O. D.)	Spacing of Supports (ft.)
1/2	6	1/2	4
3/4 or 1	8	5/8 or 3/4	6
1 1/4 or larger (horizontal)	10	7/8 or 1 (horizontal)	8
1 1/4 or larger (vertical)	every floor level	1 or larger (vertical)	every floor level

2.1 Corrugated Stainless Steel Tubing - CSST

- 2.1.1** CSST must be sized and installed properly as per the manufacture's instructions.
- 2.1.2** To install CSST, the installer ***must*** be certified by the manufacture of brand that is being used.
- 2.1.3** Each manufacture's CSST may vary in the in flow capacity. This is called Equivalent Hydraulic Diameter (EHD). Therefore each manufacture of CSST should have the EHD stamped on the CSST.
- 2.1.4** Refer to the EHD when sizing CSST or IFGC Section 402.4 (Tables 13 through 17) as a guide.
- 2.1.5** Refer to CSST Supplement in rear of this book.

2.2 Metallic Fittings (Including Valves, Strainers, Filters):

- 2.2.1 Threaded fittings SHALL NOT be used in sizes larger than 4" or fuel lines utilizing pressures above 14" W.C.
- 2.2.2 Fittings used with steel or wrought iron pipe shall be steel or malleable iron.
- 2.2.3 Cast Iron Fittings are not permitted in any gas fuel line.
- 2.2.4 PGW does not approve the use of reducing bushings on gas pipe systems.

2.3 Shut Off Valves and Unions

2.3.1 A gas valve and union must be installed in an accessible location as follows:

- A. At each appliance within six (6) feet (IFGC, (most current edition) ~ 409)
 - 1. Shutoff valve and union not permitted in a concealed locations.*
 - 2. Gas valves two inches or larger must be full open, plug lubricated type, lug type butterfly valve or a ball valve.
 - 3. Unions are not permitted in fuel lines supplying high pressure (greater than 14" W.C.). A Flange Union is acceptable. An exception will be valve trains for large packaged boilers.

Concealed Location: (PGW) - A location that requires the removal of a permanent construction to gain access to the piping or equipment. A drop ceiling would not be considered concealed since it is not permanent construction, however, a shutoff valve and union is permissible in a drop ceiling only if it is part of the gas utilization equipment located in the space. If a shutoff valve and union needs to be installed and it is not part of the equipment, the Area Supervisor must make approval.



**FIELD OPERATIONS
DISTRIBUTION AND FIELD
SERVICES DEPARTMENTS**

**RESTRICTION OF HOUSE
PIPING THROUGH PARTY
WALLS**

Effective Date: October 1, 2007

Bulletin Number #216
Supersedes: N/A

To: Distribution, FSD and Marketing Personnel

I. Purpose

To comply with the International Fuel Code (section 404.1); House piping through party walls of buildings.

II. Definitions:

Town-houses and row-homes are typically built on separate lots having distinct property ownership (address).

Condominiums are common dwelling units typically stacked vertically or share the same property ownership (address).

III. Policy

PGW will install individual gas services to properties that are considered townhouses or single family residences. House piping will not extend through any townhouse / single family residence to serve another townhouse or single family residence. All existing installations that were designed and/or installed previously to this change are exempt.

Condominiums, or common dwellings units, where common ownership of the property exists do not fall under this requirement. Based on the above, piping may extend through any such residence in order to serve another residence within the common dwelling area.

Any deviation from this policy must be reviewed and approved by the VP of Operations or his designee.

IV. Associated Procedure(s) - N/A

V. Handbooks

Field Service Department Piping Specifications and Equipment Installations – Section 3.



**FIELD OPERATIONS
DISTRIBUTION AND FIELD
SERVICES DEPARTMENTS**

**RESTRICTION OF HOUSE
PIPING THROUGH PARTY
WALLS**

Effective Date: October 1, 2007

Bulletin Number #216
Supersedes: N/A

VI. Attachments - N/A

VII. Transaction Listing

TR-2007-#02

Approved By:



Steven Groeber
Director, Field Operations & Work Planning



Michael W. Handwerk
Vice President - Technical Compliance

SECTION 3 PIPING INSTALLATIONS IN THE FOLLOWING

3.1 Tunnel

- 3.1.1** Minimum size 6' high x 4' wide.
- 3.1.2** A vent opening of 8" x 8" to the outside, or an occupied portion of the building should be installed every 50 feet.
- 3.1.3** The ends of tunnel are to be open to an occupied portion of the building. If doors are installed at the ends of the tunnel, each door must have a minimum of 4 square feet of louvered or gridded area for ventilation.
- 3.1.4** All piping must be installed in such a manner that it will be accessible for maintenance.

3.2 Piping in Solid Floors (2009 IFGC 404.6)

- 3.2.1** Piping in solid floors shall be laid in channels in the floor and covered in a manner that will allow access to the piping with a minimum amount of damage to the building. Where such piping is subject to exposure to excessive moisture or corrosive substances, the piping shall be protected in an approved manner. As an alternative to installation in channels, the piping shall be installed in a conduit of Schedule 40 steel, wrought iron, PVC or ABS pipe in accordance with Section 404.6.1 or 404.6.2.
- 3.2.2** Conduit with One End Terminating Outdoors (2009 IFGC 404.6.1) – The conduit shall extend into an occupiable portion of the building and, at the point where the conduit terminates in the building, the space between the conduit and the gas piping shall be sealed to prevent the possible entrance of any gas leakage. The conduit shall extend not less than 2 inches (51 mm) beyond the point where the pipe emerges from the floor. If the end sealing is capable of withstanding the full pressure of the gas pipe, the conduit shall be designed for the same pressure as the pipe. Such conduit shall extend not less than 4 inches (102 mm) outside the building, shall be vented above grade to the outdoors and shall be installed so as to prevent the entrance of water and insects.
- 3.2.3** Conduit with Both Ends Terminating Indoors (2009 IFGC 404.6.2) – Where the conduit originates and terminates within the same building, the conduit shall originate and terminate in an accessible portion of the building and shall not be sealed. The conduit shall extend not less than 2 inches (51 mm) beyond the point where the pipe emerges from the floor.

3.3 Crawl Space

- 3.3.1** Minimum vertical clearance of 4 feet should exist in the area where the piping is located.
- 3.3.2** All piping should be installed in such a manner that it will be accessible for maintenance.
- 3.3.3** Ample ventilation must be provided. Specific approval must be obtained for each individual case.

3.4 Piping Embedded in Concrete

- 3.4.1** Piping embedded in concrete is not permitted in industrial applications.
- 3.4.2** In other than industrial applications, gas piping may be embedded in concrete floor slabs constructed with Portland cement. Piping shall be surrounded with a minimum of 1-½ inches of concrete and shall not be in physical contact with other metallic structures such as reinforcing rods or electrically neutral conductors.
- 3.4.3** All piping, fittings and risers shall be protectively coated against corrosion.
- 3.4.4** Piping shall not be embedded in concrete slabs containing quickset additives or cinder aggregate.
- 3.4.5** All piping laid in concrete must be a minimum of schedule 40 pipe with all lengths and fittings welded.
- 3.4.6** A shutoff valve and union must be installed on the piping immediately upstream of entering the concrete slab.
- 3.4.7** A piping pressure test of 50 psig must be applied to the piping and must be witnessed by a representative of PGW prior to pouring the concrete. Please phone pressure test requests to 215~787-5130 (see Section 7.0).

3.5 Prohibited Location for Piping

- 3.5.1** Inside a Building (IFGC 404.1): Piping shall not be installed in or through a circulating air duct, clothes chute, chimney or gas vent, ventilating duct, dumbwaiter or elevator shaft. Piping installed downstream of the point of delivery shall not extend through any townhouse unit other than the unit served by such piping.

NOTE: This provision shall not apply to ducts used to provide combustion and ventilation air or to above ceiling spaces which are not concealed.

- 3.5.2** Underground Beneath Buildings: Underground gas piping is not acceptable under any building. Gas piping installed in tunnels, trenches, and crawl spaces is not considered underground piping.
- 3.5.3** Above Ceiling Locations: Gas piping may be installed in accessible above-ceiling spaces, whether or not spaces are used as a plenum. Equipment shutoff valve and union is permitted in such spaces as long as it is part of the equipment.
- 3.5.4** Concealed Locations: When installing gas piping which is to be concealed, unions, tubing, fittings, running threads, right and left coupling and swing joints consisting of a combination of fittings shall not be used.

3.6 Pipe Penetration

- 3.6.1** Pipe penetrations through concrete or masonry building elements must be encased in a protective sleeve.
- 3.6.2** The annular space between the fuel line and the sleeve must be sealed.
- 3.6.3** Pipe penetrations through cored drilled concrete do not need a protective sleeve as long as fuel line is centered in hole. Fuel line can not be in contact with concrete and fuel line must be properly supported.

P.V.C. is the preferred material for pipe sleeves. Flue pipe may be used as long as it is installed with an air space around the entire circumference of carrier pipe and all seams are sealed.

SECTION 4 UNDERGROUND PIPING

4.0 Scope of Specifications:

This section applies to underground gas piping containing “Metered” gas, which is not to be installed on private property in Philadelphia by any person, firm or agency other than employees of the Philadelphia Gas Works or their representatives, hereafter referred to as PGW.

4.0.1 “Metered” gas is gas, which has been metered (measured) by a meter owned by PGW.

4.0.2 This section applies to all installations such as piping to swimming pool heaters, incinerators, separate buildings, etc. **Procedures to install underground piping can be obtained from the PGW Distribution Department at 215-684-6368.**

4.1 Authority to Install Underground Gas Piping

4.1.1 PGW does not authorize the installation of underground gas piping in city streets, dedicated or undedicated, or property dedicated to public use. Permits for such locations must be obtained from the City of Philadelphia.

4.1.2 A contractor is not permitted to install underground gas piping without first contacting PGW. **Procedures to install underground piping can be obtained from PGW Distribution Department at 215-684-6368.**

4.1.3 No pipe smaller than 1-¼” shall be installed underground. (Exception: pool heaters, grills, gas lights, etc., which can be installed using copper tubing or approved plastic, with ½” being the minimum acceptable size for the use underground). *For approval of material to be used, contact PGW Distribution Department. Contractors using approved CSST underground piping should call 215-787-5131 or 215-787-5130 before installing.*

4.2 Inspection

4.2.1 The contractor shall notify the Distribution Department at 215-684-6368 of the construction starting date, so that PGW can inspect the installation. It is understood that any inspection by PGW shall not constitute or imply a guarantee of the future soundness of the piping.

SECTION 5 ABOVE GROUND PIPING OUTSIDE (IFGC 2009 ~ 404.7)

- 5.0** All piping installed outdoors shall be elevated not less than 3-1/2 inches (152 mm) above ground and where installed across roof surfaces, shall be elevated not less than 3-1/2 inches (152 mm) above the roof surface. Piping installed above ground, outdoors and installed across the surface of roofs shall be securely supported and located where it will be protected from physical damage. Where passing through an outside wall, the piping shall also be protected against corrosion by coating or wrapping with an inert material. Where piping is encased in a protective pipe sleeve, the annular space between the piping and the sleeve shall be sealed.

NOTE: Plastic Pipe and Copper Pipe are not permitted to be exposed aboveground.

5.1 Pipe Specifications (Aboveground)

- 5.1.1** Welded fuel line is required if **any** one of the following is present:

- a) pressure above 14" W.C.
- b) fuel line large than 4"

- 5.1.2** Systems utilizing screw pipe must meet both conditions below:

- a) Low pressure gas being delivered at 14"W.C. or below
- b) Pipe size 4" and below

- 5.1.3** Pipe outside, installed above ground must be galvanized or coated to protect the pipe from corrosion.

5.2 Valves (All Types of Pipe)

- 5.2.1** A gas shutoff valve and union must be installed in the gas line before it leaves the main building and also at the appliance or separate building, etc.

- 5.2.2** When joining connections on a high-pressure system, a plug lubricated shutoff valve or ball valve and a welded flanged union must be used.

5.3 Installation of Piping

- 5.3.1** The installation of gas piping in any building shall not cause structural stress within the building components to exceed allowable design limits

- 5.3.2** Pipe shall be supported suitable for the size of the pipe installed. (*Re: IFGC~2009~407*)

5.3.3 Gas pipe shall not be installed in or through any chimney or gas vent, clothes chute, dumbwaiter, elevator shaft or air duct, other than combustion air duct.

SECTION 6 COPPER TUBING SPECIFICATIONS

6.0 The use of Copper Tubing for fuel lines is acceptable only for outside underground installations (e.g., gas grills, gas lamps, etc.).

6.0.1 If copper tubing is used, it shall comply with Standard Type (K) or (L) of the Specifications for Seamless Copper Water Tube, ASTM B88; or the Specification for Seamless Copper Tube for Air Conditioning and Refrigeration Field Service ASTM B280.

6.1 Copper Tubing Guidelines

6.1.1 No copper tube joints are permitted underground.

6.1.2 Adapter fittings used to connect copper tube to steel must be flare joint or brazed with a material having a melting point in excess of 1000° F. Brazing alloys shall not contain phosphorous.

6.1.3 All exposed steel pipes must be galvanized or protectively coated.

6.1.4 Tubing shall be spiral wrapped with (1/2" overlap) Polyken tape.

6.1.5 Backfilling of trench shall not be performed until after a pressure test is witnessed and approved by a PGW representative.

6.1.6 Caution tape must be placed 12" below surface.

6.1.7 A pressure test of 3 psig must be witnessed by PGW and must be performed prior to connecting to the existing system and prior to installing appliance(s) and/or gas shut off valves. The FSD Training Section should be notified at 215-787-4866/67 to schedule a pressure test.

CAPACITY (CFH) STANDARD COPPER TUBE TYPE K

Length	1/2"	3/4"	1"	1-1/4"	1-1/2"	2"
10'	32	107	221	425	656	1,321
20'	23	76	156	301	464	934
30'	--	62	127	246	379	76
40'	--	54	110	213	328	661
50'	--	48	99	190	294	591
60'	--	44	90	174	268	539
70'	--	--	83	161	248	499
80'	--	--	78	150	232	467
90'	--	--	--	142	219	440
100'	--	--	--	135	208	418

SECTION 7 PRESSURE TESTING

7.0 A pressure test of new piping systems is required on other than residential piping (any single-family dwelling) prior to the appliance being connected if the length of fuel line exceeds the minimum specified in Table II. This minimum does not apply to systems supplying gas to commercial application. These establishments must all be pressure tested and witnessed by PGW at a minimum of 3 psig or 1½ times system operating pressure, whichever is greater.

NOTE: PGW shall visually inspect fuel line installations before interior walls are installed.

7.0.1 Before requesting a pressure test, make sure you have met all the requirements listed under section 7.2 (Pressure Test Requirements).

7.0.2 NO2 and compressed air are acceptable. O2, Freon and the like **are not**.

TABLE II
MINIMUM PIPE SIZE REQUIRED TO PRESSURE TEST

Pipe Size (Inches)	Length of Pipe (Minimum)
1-1/2"	100 feet
2"	75 feet
2-1/2"	50 feet
3" or Larger	Any length

* All commercial/industrial pipe will require a PIPE TEST regardless of size or length of pipe.

PRESSURE TEST TABLE

<u>Operating System Pressure</u>	<u>Test Pressure</u>	<u>Time Required</u>
4.0" w.c. to 2 psig:	3 psig	30 min.
Pressures Greater than 2 psig: Operating Pressure	1½ times system	30 min.
<p>*All Underground Piping will be referred to Distribution. If they determine the installation is minor, e.g.-a grill, fireplace etc., they will contact FSD for pressure test.</p> <p>Note: For Underground Copper Fuel Lines Only, supplying gas grills and/or gas lights, a psig test for a duration of 30 minutes is required.</p>		

7.0.3 *CO2 is no longer an acceptable inert gas to pressurize the system, as it contributes to global environmental problems.

7.0.4 The test must be witnessed by PGW and must be performed prior to connecting to the existing system and prior to installing appliances and/or gas shutoff valves. Contact your marketing representative to schedule your pressure test.

7.1 Pressure Test Gauges

A spring gauge is acceptable for pressure testing gas piping as long as it has increments of ¼ lb. or less. The midpoint of the test gauge should be near the test pressure required.

NOTE: When pressurizing a system at 50 psig, a 100 psig gauge with 1 psig increments is acceptable.

7.2 Pressure Test Requirements

The following are required before a PGW representative witnesses any pressure test 3 psig and over:

7.2.1 All branch cocks are open.

7.2.2 All appliances are disconnected. The openings must be capped or plugged.

7.2.3 No Bushings or Cast Iron Fittings.

7.2.4 Exterior piping must be galvanized or protectively coated*.

7.2.5 Sleeves installed and openings sealed.

7.2.6 Piping is properly supported.

7.2.7 Piping having pressures greater than 14" W.C.* must be marked "Hi Pressure Natural Gas" at ten (10) foot intervals.

7.2.8 Pressure test the entire fuel line.

7.2.9 Test holds for 30 minutes (exception 50 psig requires 1 hr.)

7.2.10 The pressure gauge goes to zero (0) when pressure is released.

NOTE: **These items can be done after 3 psig test has passed.*

SECTION 8 METER LOCATION

8.1.1 Meter Location and meter floor space will be determined with the assistance of the Field Services Department.

NOTE: *Department of Transportation (D.O.T.) regulations for meter installation(s) must be referenced when selecting a meter location.*

8.1.2 The gas meter area, if enclosed, must be vented to the outside or into an occupied portion of the building with openings at the top and bottom of the door or wall.

8.1.3 Minimum opening for outside air 3" x 8" or 24 square inches (each opening)

8.1.4 Minimum opening for inside air 12" x 12" or 144 square inches (each opening).

8.1.4 Adequate protection in the form of bollards must be provided by the owner to prevent any damage to the gas meter equipment, due to vehicular traffic or the storage or movement of material by use of bollards. The customer must provide adequate space to allow for routine maintenance of the gas meters by the company. It is recommended the bollards are spaced a minimum of two (2) feet from meter and the bollards are spaced three (3) feet apart. (See Exhibit A).



8.2 Separate Building

The customer may provide a separate meter building. The building should have a concrete floor and noncombustible walls (cinder block, brick, etc.). The door into the room must be large enough to permit the removal of meter and equipment. The building must be vented with two (2) openings 12" from the top and 12" from the bottom and be a minimum of one (1) square foot for each 150 square foot of floor area.

8.3 Gas meter(s) shall be located within three (3) feet of the service entrance to the building. Sufficient space must be provided at this location with a minimum of

three (3) feet between the meter and circuit breakers/fuses boxes or any other source of ignition or any source of heat which might damage the meter. The customer's fuel line must be extended to within two (2) feet of the proposed meter location. Also, a clear area of at least three (3) feet must be provided across the front of the meter for reading and general maintenance purposes.

- 8.4 Drawings for some proposed PGW metering installations will be prepared by our Engineering Services Department and will be submitted to the contractor and the Field Services Department for review and comment.
- 8.5 An unobstructed passageway of at least 3' wide x 7' high should be available from the outside of the building to the meter area for installation and maintenance of meters.

Outside Meter & Service Protection



High Pressure Service Installed Outside
Protected By Bollard & Hidden By Planter



Bollards Installed to Protect



Light Commercial Multi-Metered Installation, Protected By Bollards and Fence. In the rear of Shopping Center Loading Dock.

SECTION 9 Venting of Regulators

- 9.0.1** Appliance pressure regulators are required on all gas utilization equipment.
- 9.0.2** Regulators must be vented unless approved with an internal relief.
- 9.0.3** Appliance pressure regulators with a capacity of 1100 C.F.H. or less can use leak-limiting devices. However, Leak Limiters larger than 1/8" N.P.T. are not permitted unless specified by the regulator manufacturer.
- 9.0.4** Leak Limiters are not permitted on gas pressure switches.
- 9.0.5** Regulator vent outlets must not be reduced in size.
- 9.0.6** Limiters on appliance regulators installed in burner compartment are not permitted. The regulator must be vented to outside.

SECTION 10 MANIFOLDING OF VENTS

- 10.1** Manifolding of regulator vents is not recommended. If manifolding is done, the cross-sectional area of the manifold pipe must be equal to or greater than the sum of the cross-sectional areas of all the individual vents and must be vented outside. (See Table III, page 29).
- 10.2** Manifolding vents of more than one (1) appliance gas train is not permitted.
- 10.3** Manifolding the vent valves of more than one (1) appliance gas train is not permitted
- 10.4** Manifolding of vents includes the gas pressure regulators and the gas pressure switches. Vent valves must be vented separately and can not be manifolded.

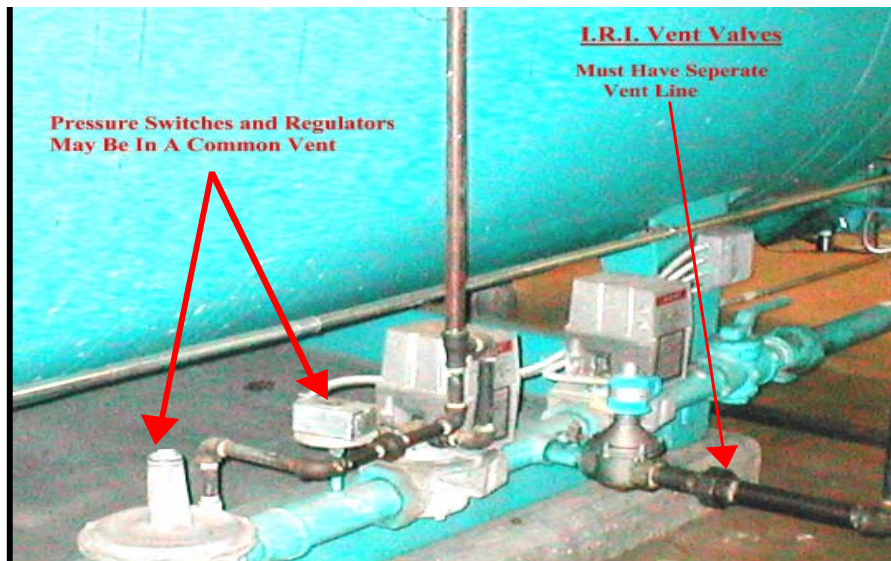

- 10.5** For every 30 foot run horizontally, the manifold size must be increased by (1) pipe size. The vent run should be as short as possible. Runs over 30' may cause the regulators to fluctuate.

**Table III - Determining Manifold Size
for Regulator or Control Line Vents**

<u>Pipe Size</u>		<u>Inside Diameter</u>	<u>Cross-Sectional Area – Inside +</u>
1/8"	.125"	0.269	0.057
1/4"	.250"	0.364	0.104
1/2"	.50"	0.622	0.304
3/4"	.750"	0.824	0.533
1"	1.0"	1.049	0.864
1-1/4"	1.250"	1.38	1.495
1-1/2"	1.50"	1.61	2.036
2"	2.0"	2.067	3.356
2-1/2"	2.50"	2.469	4.788
3"	3.0"	3.068	7.393
4"	4.0"	4.026	12.73
5"	5.0"	5.047	20.004
6"	6.0"	6.065	28.89

NOTE: + the formula for finding the area of a circle is $A = 3.1416 * R^2$

To better understand formula, these are the steps: A stands for the Area which is the inside diameter; 3.1416 is decimal for **PI**; D - represents the diameter of a circle; R - represents the radius of the circle (R is equal to D times 0.5); • is symbol for multiplying

Let's do an example using 1" pipe! The inside diameter is 1.049. When working with circles the radius of the circle can be found by multiplying the inside diameter of the circle by 0.5. You can now apply the formula as shown below.

Formula: $Cross\text{-}Sectional\ Area = Pi * (Inside\ Diameter * .50)^2$
 $3.1416 * (1.049 * .50)^2 = 0.864$

Example Problem: Determine manifold size for two (2) regulators with 3/4" vents and two (2) pressure switches with 1/4" vents.

Solution: (1) Find cross-sectional areas for the vents

$$2 - 3/4'' \text{ regulator vents} \quad \sim .533 \times 2 = \quad 1.066$$

$$2 - 1/4'' \text{ pressure switch vents} \quad \sim .104 \times 2 = \quad \underline{.208}$$

1.274

The sum of cross-sectional areas and your manifold size must be equal to or greater than the sum. Therefore, the sum is 1.274 and if you look at Table III you would need a 1 1/4" manifold.

SECTION 11 TERMINATION OF REGULATOR OR CONTROL VENTS

- 11.1** Regulator or control vents must terminate at least four (4) feet below windows, doors or gravity air intakes. Horizontal clearance from windows, doors or gravity air inlets shall be at least three (3) feet. Clearance above windows, doors or gravity air inlets must be at least one (1) foot.
- 11.2** The vent shall terminate outside with a screened 90-degree elbow face down.
- 11.3** Regulator or Control vents must not terminate below a forced air inlet. They must terminate at least three (3) feet above a forced air inlet if within ten (10) feet horizontally.
- 11.4** Regulator vents or any other types of vents are not permitted to be discharged into a gas equipment flue or exhaust system.
- 11.5** All vent lines shall be constructed of rigid metallic pipe. Copper is acceptable. Plastic is not acceptable.

SECTION 12 GENERAL ~ COMBUSTION AIR AND VENTING (IFGC, 2009)

- 12.1** Air for combustion, ventilation and dilution of gases for gas utilization equipment installed in buildings shall be obtained by one of the applications covered in IFGC, 2009, Section 304).
- 12.2** Equipment requiring venting should be vented according to the manufacturer instructions and the International Fuel Gas Code 2009.
- 12.3** The minimum standard volume of air shall be 50 cubic feet per 1,000 Btu/hr.

SECTION 13**GAS VENTS SERVING EQUIPMENT ON MORE THAN ONE (1) FLOOR - (IFGC, 2009 ~ 504.3)**

- 13.1** A single or common gas vent is permissible in multistory installations to vent Category 1 gas utilization equipment located on more than one (1) floor provided the venting system is designed and installed in accordance with approved engineering practices.
- 13.2** All gas utilization equipment connected to the common vent shall be located in rooms separated from habitable space. Each of these rooms shall have provisions for an adequate supply of combustion, ventilation and dilution air that is not supplied from habitable space.

SECTION 14 CONTAMINATED AIR (IFGC, 2009 ~ 304.12)

14.1 Whenever air used for combustion is contaminated with halogenated hydrocarbon fumes from cleaning agents, spray cans, or chlorine, the products of combustion can cause premature corrosion and/or failure of heated metals such as heat exchangers, flue pipes, burners etc. Any equipment installed in such environments must be installed in a room separate or partitioned off from areas with provisions for combustion and dilution air from outdoors. Exception is direct vent equipment.

(IFGC 304.12): – Protection from fumes and gases – Where corrosive or flammable process fumes or gases, other than products of combustion, are present, means for the disposal of such fumes or gases shall be provided. Such fumes or gases include carbon monoxide, hydrogen sulfide, ammonia, chlorine and halogenated hydrocarbons.

In barbershops, beauty shops and other facilities where chemicals that generate corrosive or flammable products, such as aerosol sprays, are routinely used, non-direct vent-type appliances shall be located in a mechanical room separated or portioned off from other areas with provisions for combustion air and dilution air from the outdoors. Direct-vent appliances shall be installed in accordance with the appliance manufacturer's installation instructions.

SECTION 15 EMERGENCY GAS GENERATORS

15.0 An emergency gas generator must be installed according to the manufacturer's specification, the National Fire Protection Association NFPA and the National Electric Code NFPA 70.

15.1 Philadelphia Fire Code (2007) F-604.1.1.1 – Generators employing natural gas as a fuel shall have the supply equipped with a separate shut-off valve. The valve shall be tagged “Emergency Power Supply – Not to be Shut off During an Emergency.”

15.2 Emergency Generator Policy

New Gas Service Requirements:

1. Marketing will require, in writing from the customer, documentation stating specifically what this emergency generator will be used for, i.e., back-up power for computers, emergency lighting, fire protection equipment, etc. This information will be indicated on the FIR sent to Distribution, including the required load. This documentation will be kept in the Marketing files for each customer.
 - a. Service Requirements:
 - If the service terminates outside; then only one (1) service is required.
 - If the service terminates inside, then two (2) separate services will be required. The two services must be installed within 5’ of each other. In most cases, the second service will be “teed” off of the first service. If services are installed in a common trench, separation shall be a maximum of 2’ and a minimum of 1’.
 - b. Service Valves
 - Curb valves will be installed per PGW’s GS installation standards. The outside service valve will be tagged “emergency generator” by PGW.
 - c. Meters, Customer Fuel Lines and Shut off valves
 - A separate dedicated fuel line will be required to service just the emergency generator. No other equipment will be permitted to be installed on this line. This line will have a dedicated PGW meter. Emergency generators should have a GS rate.
 - A separate shut off valve will be required for any fuel line which serves an emergency generator. The shutoff valve and/or meter for the emergency generator will be tagged emergency generator line by PGW.

Existing Services to Emergency Generators:

1. This section covers existing services which supply emergency generator equipment. When PGW discovers a service line or must work on a service line (including renewal or enlargement or meter replacement) which supplies gas to an emergency generator OR when a current customer requests additional work, which would require PGW to tear down and rebuild the existing meter stations.
2. For change of load requirement (i.e. – enlargements) Marketing will require, in writing from the customer, documentation stating specifically what this emergency generator will be used for, i.e., back-up power for computers, emergency lighting, fire protection equipment, etc. This documentation will be kept in the Marketing files for each customer. In the case of a service enlargement, this information will be indicated on the FIR sent to Distribution, including the required load.
 - a. Service Requirements:
 - The installation will be considered a “Gas-On” situation for hazard inspection.
 - PGW will make no changes to the existing service line configuration for the sole purpose of supplying or changing the supply configuration for the emergency generator
 - b. Service Valves
 - A curb valve will be installed per PGW’s GS installation standards. The outside service valve will be tagged “emergency generator” by PGW.
 - c. Meters, Customer Fuel Lines and Shut off valves
 - This section recognizes that there could be two situations and handles each differently:
 - There is an emergency generator existing (already installed on location), “Gas On” situation.
 - The customer is adding an emergency generator.
 - Existing emergency generator
 - A separate shut off valve will be required on the fuel line which serves an emergency generator. This shutoff valve for the emergency generator will be tagged “emergency generator” by PGW.
 - Minimum Regulation: Philadelphia Fire Code Regulation F-604.1.1 (R) and NFPA.

- Adding an emergency generator
 - A separate dedicated fuel line will be required to service just the emergency generator. No other equipment will be permitted to be installed on this line.
 - A dedicated PGW meter will be installed on this fuel line.
 - A separate shut off valve will be required for any fuel line which serves an emergency generator. The shutoff valve and/or meter for the emergency generator will be tagged “emergency generator” by PGW.

Enforcement of Services to Emergency Generators:

1. This policy will serve as a common sense guide and good safety practices should be the ultimate decision driver when deciding to turn gas on to a customer.
2. This section covers PGW’s recourse if the above stated PGW’s requirements for emergency generator are not met. PGW recognizes that three distinct situations could occur and will treat each one independently.
 - a. New Installation – New Service, New Customer
 - If the emergency generator does not have a Shutoff valve, separate fuel line, and dedicated meter.
 - Do not turn on the gas to any installed equipment, leave all valves off and locked.
 - Red tag the installation noting the violation(s).
 - Inform the customer what is needed to correct the installation.
 - b. Existing Installation – New emergency generator (Gas On Policy)
 - If the emergency generator does not have a shutoff valve, separate fuel line, and dedicated meter.
 - Existing emergency generator
 - A separate shut off valve will be required on the fuel line which serves an emergency generator. This shutoff valve for the emergency generator will be tagged “emergency generator” by PGW.
 - Minimum Regulation: Philadelphia Fire Code Regulation F-604.1.1 (R) and NFPA.
 - Do not turn on the gas to the emergency generator.
 - Leave the valve off and locked or require the customer to physically disconnect the emergency generator from the service line.
 - Red tag the installation noting the violation(s).
 - Inform the customer what is needed to correct the installation.
 - Gas can be restored to other installed equipment.

-
- c. Existing Installation – With an existing emergency generator (Gas On Policy)
 - o If the emergency generator does not have a shutoff valve.
 - Do not turn on the gas to any installed equipment, leave all valves off and locked or require the customer to physically disconnect the emergency generator from the service line.
 - Red tag the installation noting the violation(s).
 - Inform the customer what is needed to correct the installation.
 - 3. If at a later date PGW discovers additional equipment piped into the emergency generator line. (Gas On Policy).
 - o If the emergency generator does not have a shutoff valve.
 - Do not turn on the gas to any of the installed equipment, if requested, leave all valves off and locked or require the customer to physically disconnect the emergency generator from the service line.
 - Red tag the installation noting the violation(s).
 - Inform the customer what is needed to correct the installation.

SECTION 16 CHIMNEY USED TO VENT CATEGORY 1* – GAS EQUIPMENT

- 16.1** Always be guided by the manufacturer's installation instructions on how to properly vent the appliance.
- 16.2** Masonry chimneys must be properly lined ** and in good condition except as noted in B.
- A. New chimneys must be sized according to the latest edition of the International Fuel Gas Code. It is the installers' responsibility to properly size the chimney. PGW DOES NOT SIZE CHIMNEYS.
 - B. An existing unlined masonry chimney can be utilized for venting replacement Category 1 appliances, provided the chimney is in good condition. If repairs are needed, the chimney can be relined with a U.L. listed flexible liner specifically listed for use with such appliances.

*Category 1 - An appliance which operates with a non-positive vent static pressure and with a vent gas temperature that does not produce excessive condensation in the vent.

**Properly lined - Terra cotta, Stainless Steel or other approved material that will resist corrosion, erosion, softening, or cracking from vent gases at temperatures up to 1800° F. A brick chimney is not considered properly lined.

16.3 Chimney Previously Used For Oil

- 14.3.1 A chimney that was previously used for venting a solid or liquid fuel burning appliance can be used to vent a Category 1 gas appliance as long as the chimney is properly lined and cleaned (See definition of properly lined).

16.4 Chimney Passageway

16.4.1 An unused chimney can be used as a passageway for gas vents. The vents must be "B" vent or plastic depending on the proper vent for the heater. Termination of the vent must be above the existing chimney when used as a passageway. Single wall vents will not be accepted.

16.4.2 If the chimney is used as a passageway, another appliance cannot be vented into the same chimney.

16.5 Cleanouts

A cleanout is required as follows:

- 1 ~ All Masonry chimneys.
- 2 ~ All “B” vent chimneys used in residential applications.
- 3 ~ All “B” vent chimneys being utilized to Common Vent.

Exceptions are:

- 1 ~ Flexible chimney liners (unless specified by the Manufacturer).
- 2 ~ Suspended gas utilization units e.g. Unit Heaters, etc. (unless specified by Manufacturer).
- 3 ~ Venting systems designated and installed in accordance with approved engineering methods.
- 4 ~ All Commercial / Industrial “B” vent chimneys where the total aggregated inputs of the appliance being vented are 1 million BTU per hour or more.

SECTION 17 CATEGORY II, III AND IV GAS EQUIPMENT

17.1 Category III and IV appliances operate with a positive pressure in venting system while Category II operates with a negative pressure. Always be guided by the manufacturer's installation instructions for proper venting methods and materials for these appliances.

SECTION 18 PGW BOOSTER PUMP INSTALLATION REQUIREMENTS

- 18.1** A piping plan for the proposed booster pump installation must be submitted to PGW's Marketing Department before work begins.
- 18.2** All gas compressor booster pumps shall be installed and maintained according to the manufacturer's instruction.
- 18.3** A gas-air check valve must always be installed ahead of the booster pump, between the pump and the meter, to prevent an accidental flow toward the meter.
- 18.4** *A manual reset low pressure sensing device must be installed between the meter and the pump to shut down the booster in the event of low inlet pressure.
- 18.5** If several appliances are not on the same fuel line as an appliance being supplied gas at an elevated pressure from a booster pump, a bypass is recommended around the booster pump provided that the appliances can operate on low pressure.
- 18.6** The method of connection between the inlet valve and the booster pump and the outlet of the booster pump and the fuel line shall be made as specified in the sketch in **exhibit F**. The Field Services Department must approve any variation to the method of connection.
- 18.7** Any questions regarding the booster pump requirements can be addressed by calling 215~787-5130 Monday through Friday between the hours of 7:30 A.M. and 4:00 P.M.
- 18.8** A booster pump will run continuously unless it is interlocked with the appliances the booster supplies. It is recommended that the booster pump be wired through a control panel interlocked with the equipment that needs to operate at elevated pressure.

*Acceptable Pressure Switch: Honeywell C437E1038 or equivalent.
Break on pressure fall, ½" to 5½" W.C. Control should be set at 3.5" W.C.

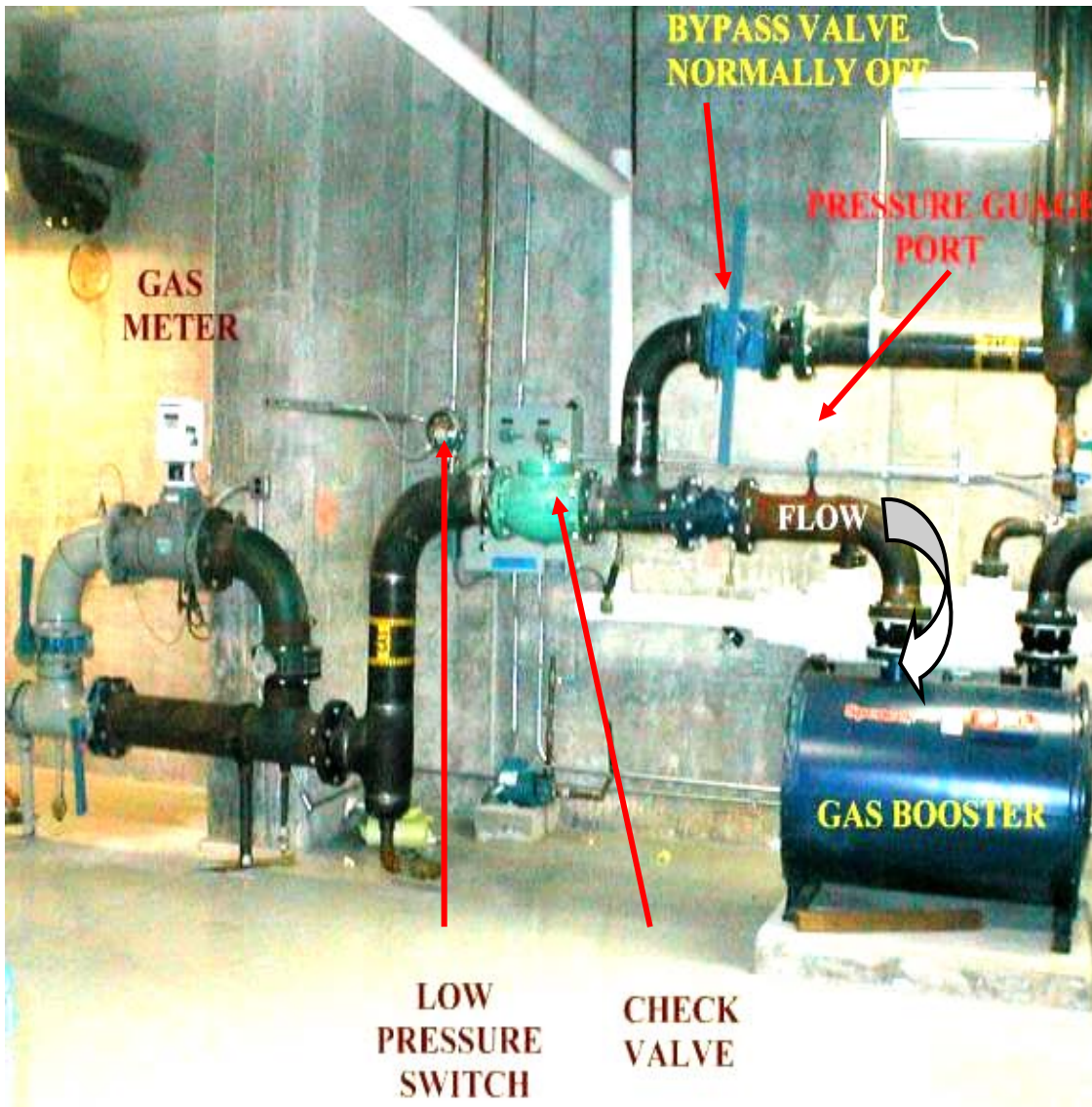

LOW CAPACITY BOOSTPAK



Low Capacity BoostPak

HIGH CAPACITY BOOSTPAK



High Capacity BoostPak

SECTION 19 COMMERCIAL AND INDUSTRIAL TURN ON

- 19.1** All appliances must be installed and ready before gas is turned on. If this cannot be accomplished and the customer needs gas for heat to complete inside work, the Supervisor of the Commercial/Industrial Section must be contacted for approval at 215~787-5130.
- 19.2** Ansul valves, if installed, must be visible. If this cannot be accomplished, the Supervisor, Commercial/Industrial Section, must make approval.
- 19.2.1 Ansul valves, if installed, must be charged at time of turn-on for ***Gas to be turned on.***
- 19.2.2 A solenoid valve for cooking equipment can be located in a drop ceiling as long as reset is accessible.
- 19.3** All fuel lines going through floors in kitchens must be sleeved. This prevents water used to clean floors from coming in contact with fuel line and corroding it.

SECTION 20 FLEXIBLE CONNECTORS ON APPLIANCES

Flexible metal appliance connectors are permitted to connect gas appliances if the connector meets ANSI.Z21.24 (stationary appliance) or ANSI.Z21.69 (movable appliance) standards. The flexible connector should not be run into a house heater cabinet. Rigid pipe must be used to extend the control piping outside the cabinet to the connector. A shutoff valve is required upstream of all flexible metal appliance connectors. Also a restraining device (**exhibit C**) must be attached on all movable appliances.

- NOTE:
- (1) The ANSI.Z21.24 flexible connector is the one used on domestic appliances.
 - (2) A Sediment trap is required on all gas utilization equipment (exception: Gas range, Domestic Dryer and movable appliances.)

EXHIBITS

Exhibit A - Bollard Standard

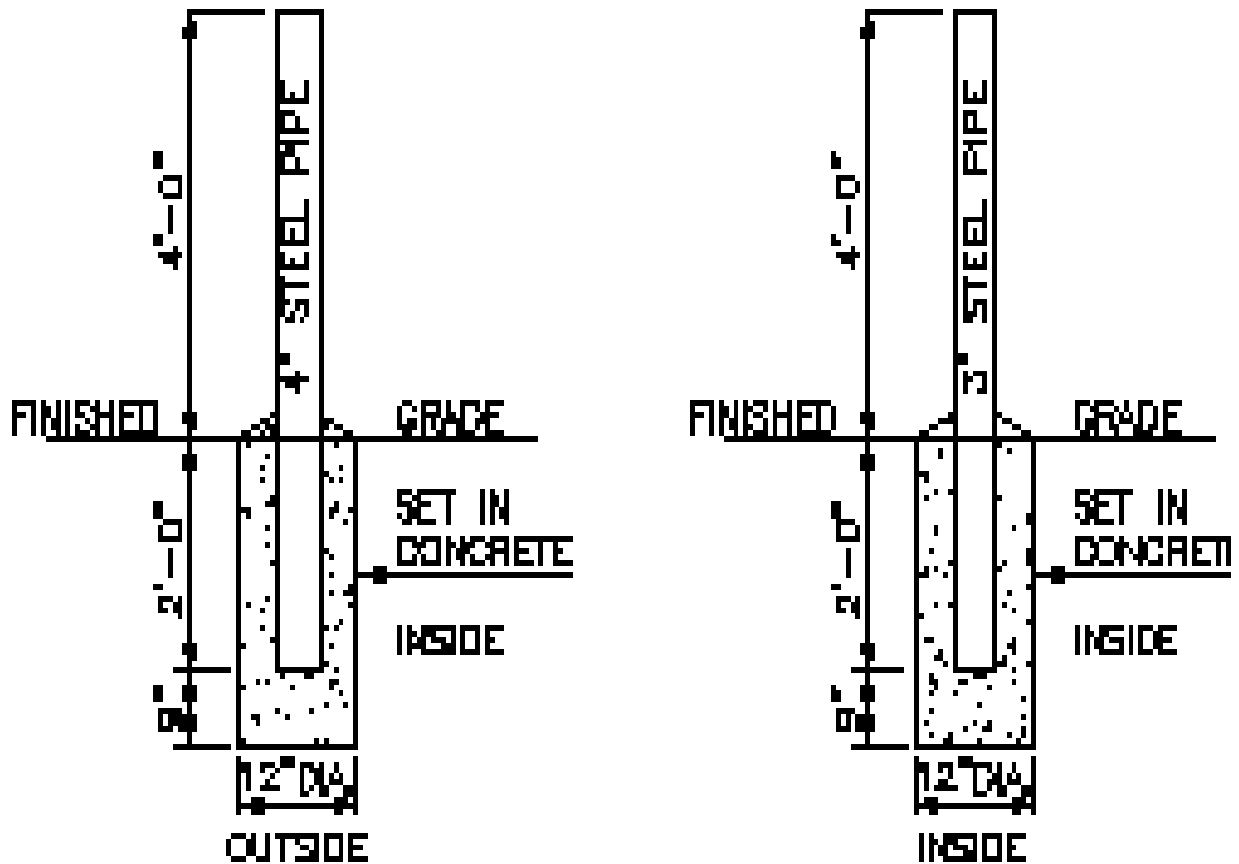

	<u>Instructions</u>	<u>Materials</u>		
1.	Dig post hole for bollard.	BLACK STEEL PIPE SCH 40 electric resistant Welded API 5L, Grade B		
2.	Partially fill hole with concrete mix.			
3.	Insert Pipe.	<u>Size</u> 3" 4"	<u>Wall Thickness</u> 0.216" 0.237"	PGW Code #10111301 PGW Code #10111301
4.	Fill hole.			
5.	Fill pipe with concrete mix.	Concrete Mix	PGW Code #10660743	
6.	Support bollard and protect from damage while concrete cures.	Sand Mix Aluminum Paint	PGW Code #10660789 PGW Code #10630713	
7.	Paint with appropriate paint.	Green paint	PGW Code #10630782	

EXHIBT B Three Meter Header

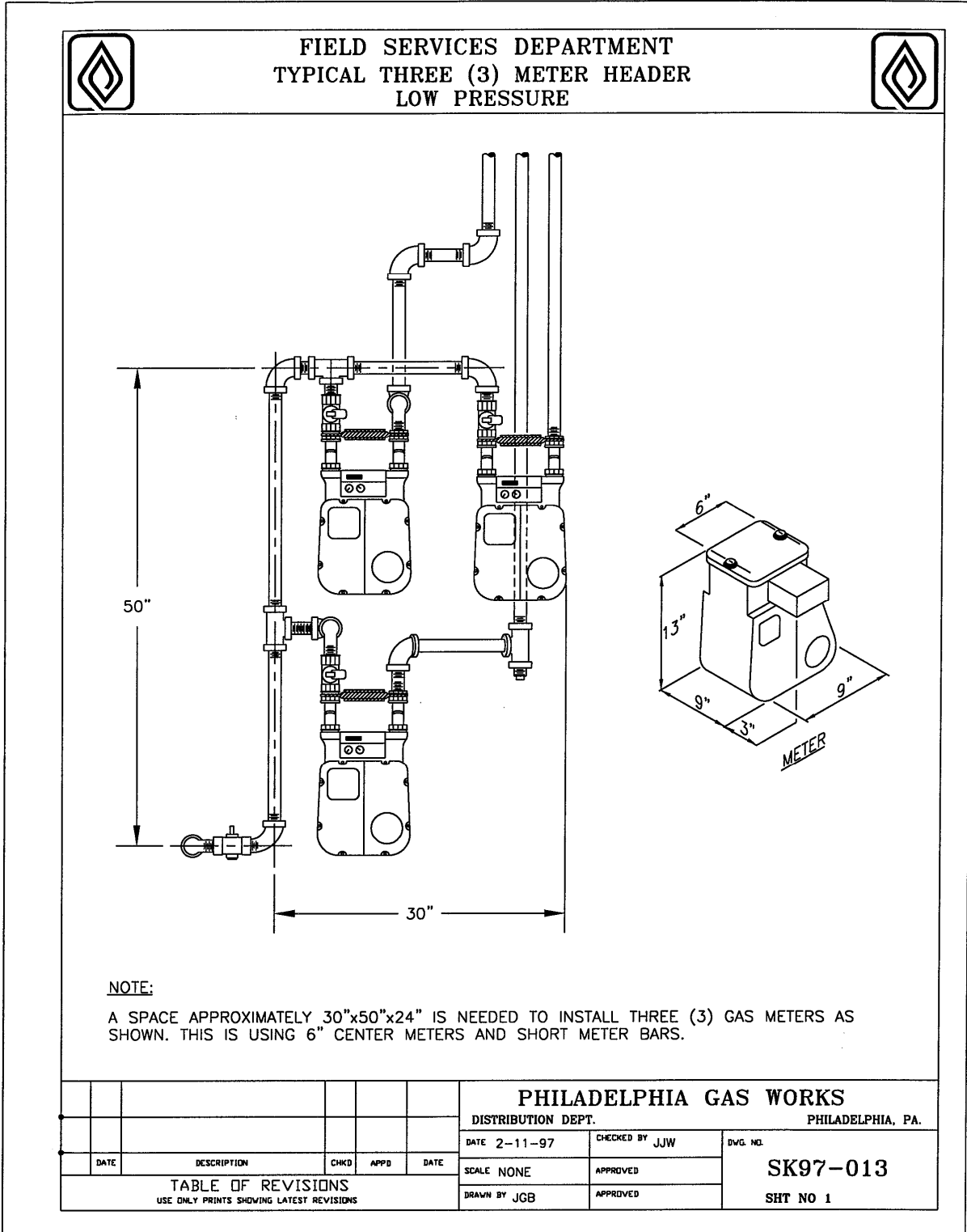
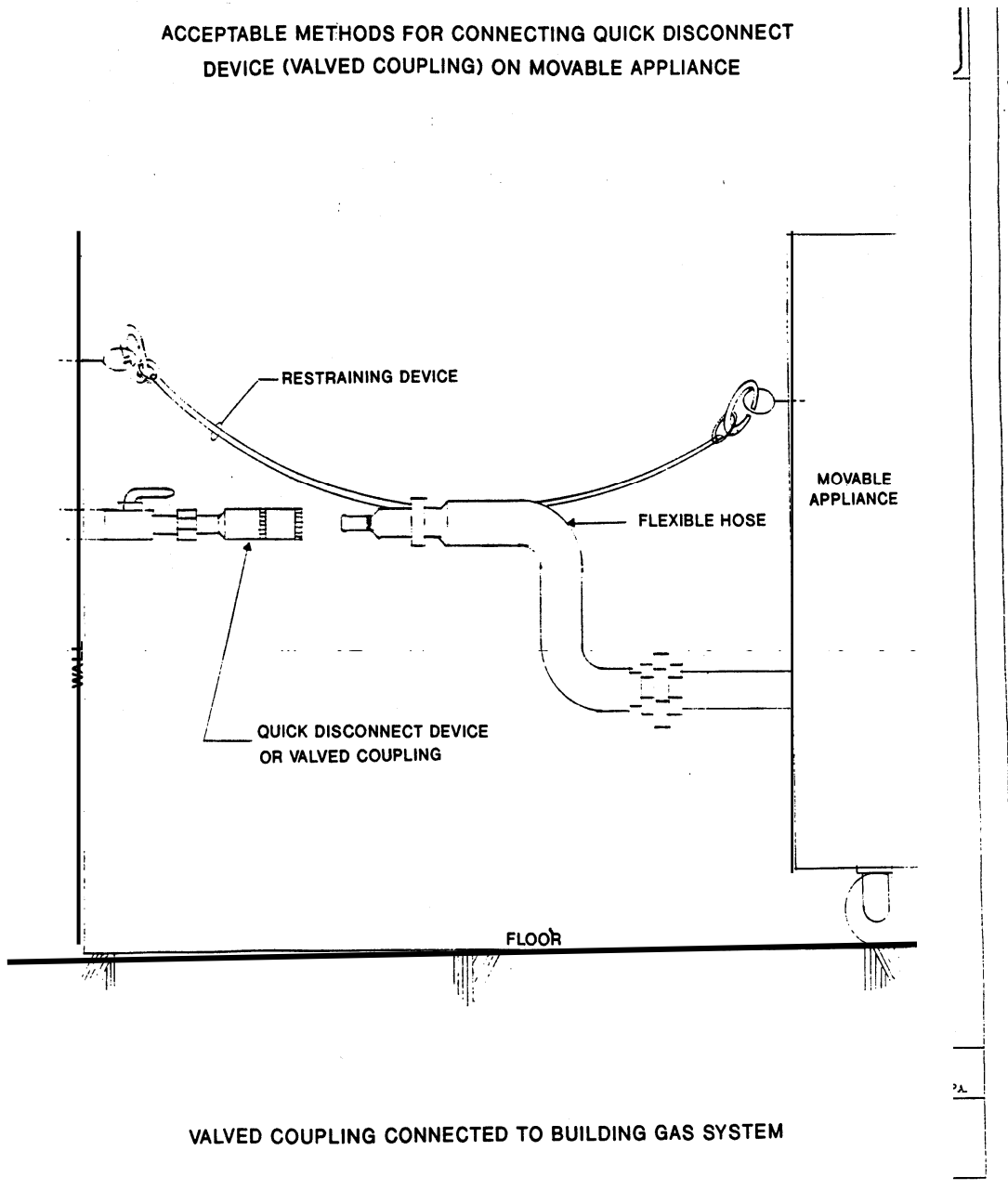

EXHIBIT-C

ACCEPTABLE METHODS FOR CONNECTING QUICK DISCONNECT
DEVICE (VALVED COUPLING) ON MOVABLE APPLIANCE



VALVED COUPLING CONNECTED TO BUILDING GAS SYSTEM

EXHIBIT-D

TABLE 1

VALVED COUPLING CONNECTED TO BUILDING GAS SYSTEM

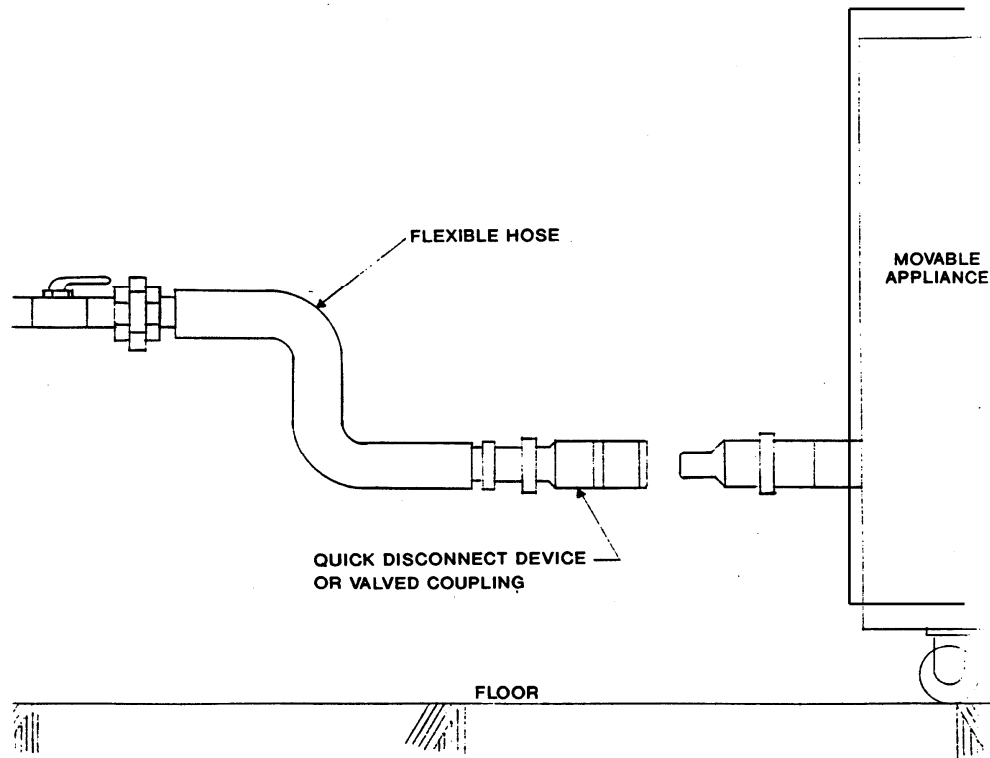

VALVED COUPLING CONNECTED TO HOSE OUTLET

EXHIBIT-E

TYPICAL DRIP/SEDIMENT TRAP
FOR FUEL LINE

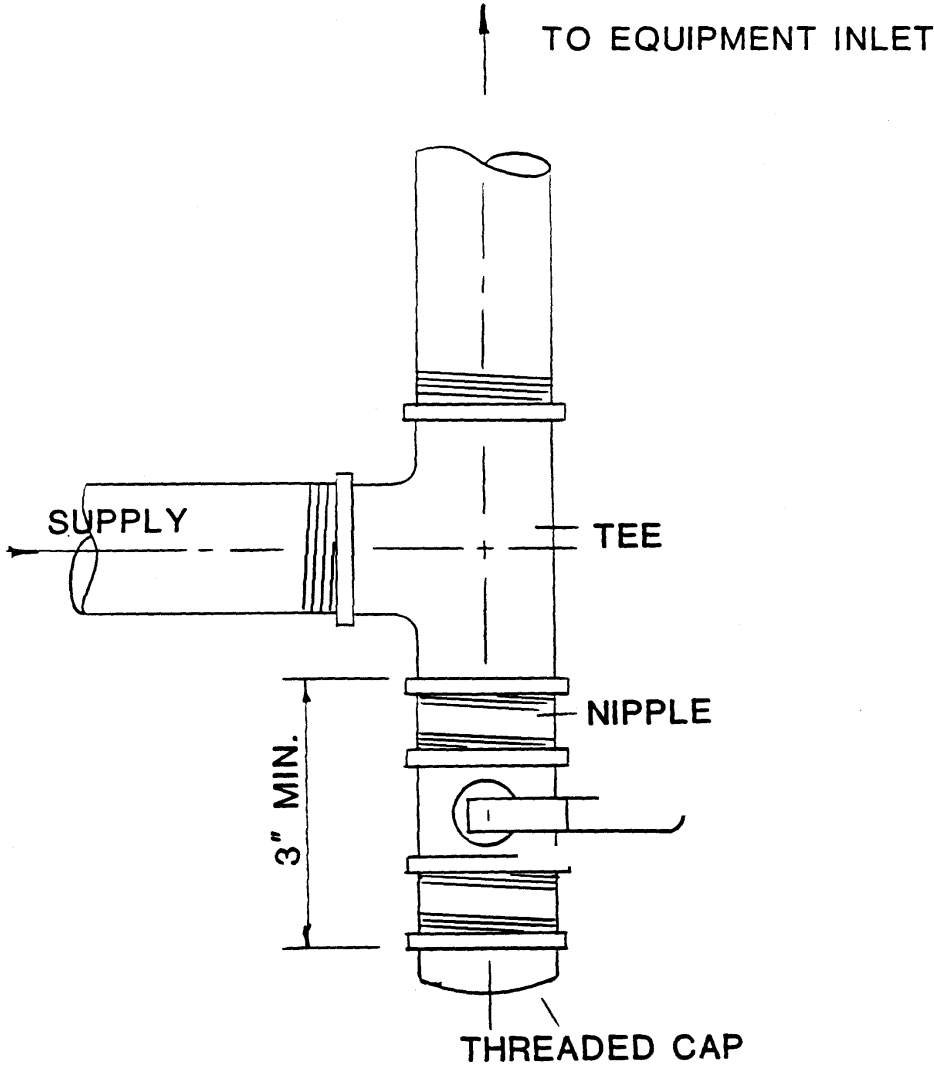

A Ball Valve is not needed on pressures 14" W.C. or lower.
Note: 3" Min. must be maintained if ball valve is not used.

EXHIBIT F- Booster

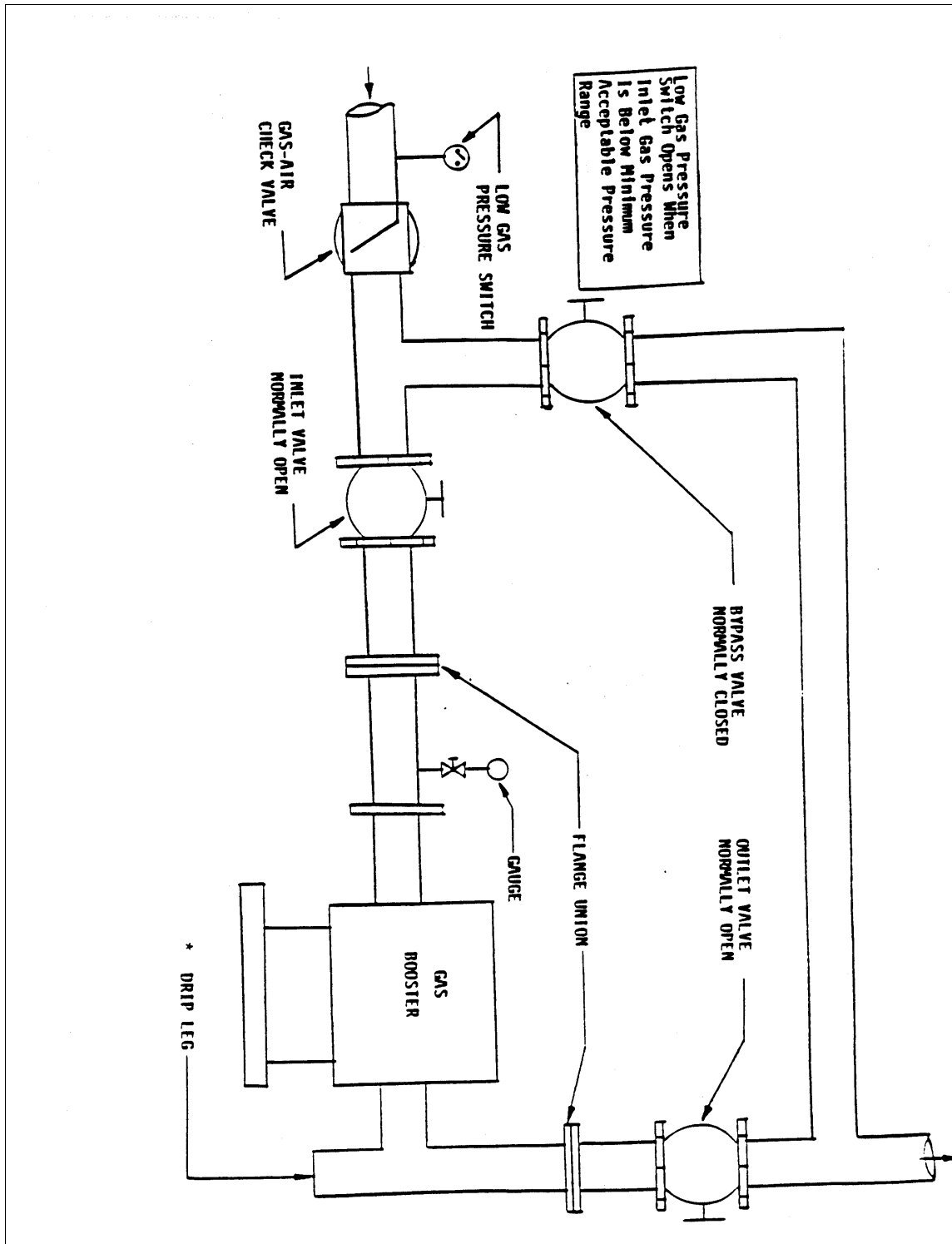

Exhibit G

Diversity Factors

	1- 2	3- 5	6- 10	11- 15	16- 20	21- 30	31- 40	41- 50	51- 60	61- 75	Over 75
Ranges	100%	80%	60%	50%	40%	35%	30%	25%	20%	15%	10%
Water Heater	100%	90%	80%	70%	65%	60%	55%	50%	45%	40%	30%
Dryer	100%	80%	60%	50%	40%	35%	30%	25%	20%	15%	10%
Heaters	100%	100%	100%	95%	90%	85%	85%	80%	80%	75%	75%
Bunsen Burner	100%	95%	90%	85%	80%	75%	70%	65%	60%	55%	50%

PHILADELPHIA GAS WORKS

FIELD SERVICES DEPARTMENT

POLICY & REQUIREMENTS

FOR

CORROGATED STAINLESS STEEL TUBING

(CSST)

SUPPLEMENT

January 2010

CORRUGATED STAINLESS STEEL TUBING (CSST)

Maximum Allowable Pressure

All CSST material intended for use, as a fuel line must be approved by CSA for that application. Currently, all approved CSST materials are rated for use up to a maximum operating pressure of 5 PSI.

CSST material will fall under the same guidelines as rigid pipe as required by PGW's Piping Specification Guide. This particularly applies to the requirements for fuel lines carrying elevated gas pressures and the requirement that these fuel lines must be welded. PGW will permit the following exception regarding the use of CSST and elevated gas pressure in the customer's fuel line. When using CSST at elevated pressures (14" WC and above) PGW will permit the installation of a continuous length of CSST tubing that extends from the outlet of the meter to the point the fuel line is connected to the appliance. Also, the CSST must be exposed or installed in a ventilated chase. ***PGW will not approve any installation of CSST with a gas pressure 14" WC or above that contains threaded fittings.*** The installer must use the manufacturer's recommended fittings to connect the CSST tubing to the outlet of the gas meter and the CSST tubing to the appliance. It is recognized that the connection at the utilization equipment will require a shut-off cock, an appliance regulator and a union. Therefore, the use of a threaded nipple will be permitted to make the connection to the appliance.

Typical Connection at an Appliance

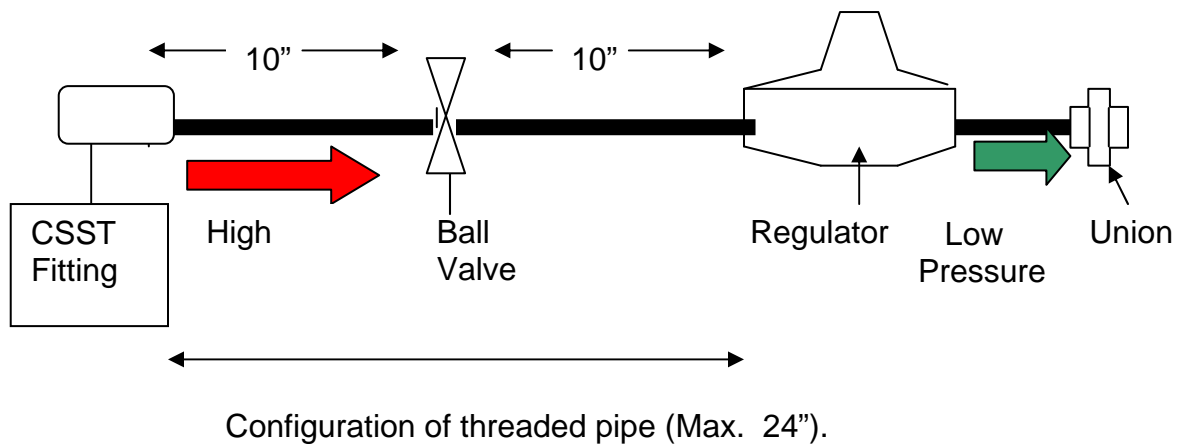

A. Introduction

Corrugated Stainless Steel Tubing (CSST) is becoming increasingly popular in the gas industry. There are a number of different companies manufacturing CSST, each incorporating their own patented connection process. Therefore, mixing of materials (one manufacturer's tubing using another manufacturer's fittings) is not permitted.

To install a particular manufacturer's product, a certification is required proving you have passed an installation and guideline course conducted by a certified representative of that particular product. Being certified to install one particular manufacturer's product does not qualify a person to install another manufacturer's product. The installer *must* be certified on the product he/she intends on installing.

Where a conflict exists between manufacturers' guideline and local codes, local code will always prevail.

CSST tubing is CSA (formerly AGA) approved as an alternative to traditional rigid, iron pipe. CSST is also approved to handle a maximum operating pressure not to exceed 5 PSI.

Unless otherwise listed in this guideline, CSST will fall under the same general rules and guidelines governing the use of rigid, iron fuel line by Philadelphia Gas Works. This is particularly the case regarding piping test; CSST shall not be treated any different than hard pipe in regards to leak testing.

Individual product lines also offer accessory products such as striker plates, outdoor termination fittings, manifolds, regulators etc. When specifically required, these products should be used, especially when protection of the CSST is concerned. For example, passing through studding material (wood or metal) a striker plate must be used. When passing through metal framing, protection must be offered to protect the product from the sharp metal edge.

CSST "pre-fabricated" pipe manifolds are not required to be used by the installer.

CSST installed underground must be approved by the Industrial Supervisor before being installed. Call 215-787-5130 or 215-787-5131.

CSST installation issues dating before release of these guidelines (pre-existing conditions) will be addressed on a case by case basis with decision making authority belonging to FSD General Supervisor position or above. It would be impossible for this guideline to anticipate and cover every possible variation in housing configurations and construction applications, which are not covered in this guide.

For applications beyond the scope of the guide, contact the PGW technical support at 215-787-4866 or 215-787-4867 or the particular manufacturer.

B. Residential vs. Commercial vs. Industrial Dwellings

Residential applications shall be defined as any single family dwelling or multiple family dwellings where each unit has its own separate meter or one meter supplying less than five (5) units.

Commercial and Industrial buildings would consist of any building not used for residential purposes. Apartment buildings having one (1) meter supplying five (5) or more units will be considered commercial. Industrial applications will consist of a property containing any one appliance with a Btu rating in excess of 500,000 Btu's.

C. Maximum Allowable Pressure

All CSST material is CSA approved for 5 pounds maximum operating pressure.

CSST material will fall under the same guidelines as hard pipe as required by PGW's Piping Specification Guide. This particularly applies to threaded and welded pipe applications and the pressure they are permitted to handle.

D. Piping Tests

1. Residential Piping Tests

Residential applications shall be tested in the same manner as iron pipe. Standard meter dial testing will be required on all orders whether initiating gas service or turning gas back on.

When warranted and /or instructed by supervision, an alternate means of testing may be applied at the discretion of supervision or the PGW representative on the job.

2. Commercial / Industrial Piping Tests

CSST tubing will fall under the same guideline as applied to rigid hard pipe.

Commercial / Industrial applications shall be tested in the same manner as iron pipe. 1- ½ times the operating pressure with a minimum 3-pound test.

E. Meter Connections

1. CSST shall not be permitted for direct connection into the meter bar (outdoor or indoor sets) or the vertical piping connected to the outlet of the meter.
2. All meter sets (INDOORS AND OUTDOORS) should be piped in with hard rigid pipe to the CSST material.
3. For outdoor meter sets, the use of an outdoor termination fitting (supplied by the specific manufacturer) should be used to connect CSST to hard pipe existing meter. No CSST should be exposed outdoors at the meter.
4. When CSST termination fitting fails to encase tubing passing through an outside wall the tubing should be sleeved with PVC, electrical conduit or iron pipe with both ends sealed.

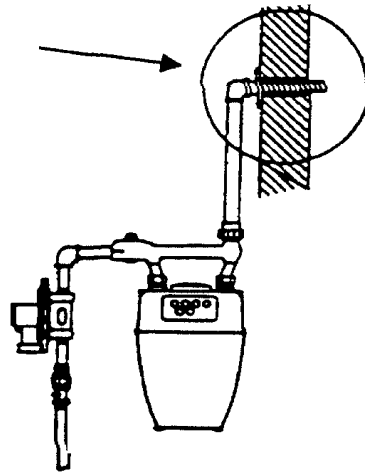

Required Meter Connection

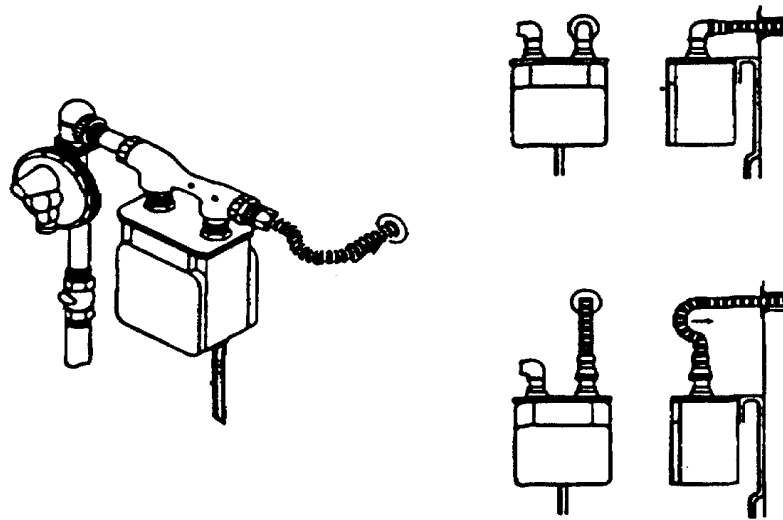

Illegal Meter Connection

F. CSST Connections

1. CSST connections are approved as per IFGC and CSA for installation in a concealed location.
2. Although preferable to run CSST straight and level, PGW will not enforce installation matters that are deemed unsightly by the inspector. CSST shall be properly secured with approved materials at required intervals to prevent excessive sagging in the fuel line.
3. Inter-mixing CSST (hybrid connections) with standard iron pipe is permissible. *For example:* Placing iron pipe / fittings within a CSST system for purposes of reducing to a smaller diameter tubing or branching off in another direction.

Use as Appliance Connector

1. Use of CSST materials as an appliance connector (flexible connector) is not permitted.
2. Connecting residential ranges, dryers, etc "from" CSST "to" an appliance using an approved flexible connector is permitted provided:
 - (a) A termination fitting is visible above the floor or on the outside of a finished wall. Some termination fittings are designed to secure to rough framing, in these cases part of the termination fitting should be visible as proof that a CSST fitting is not embedded in the floor or wall.
 - (b) An appliance termination fitting is secured above the floor or on the outside of finished wall.
 - (c) An appliance shut-off valve is installed exiting the flange mount fitting for movable appliances.

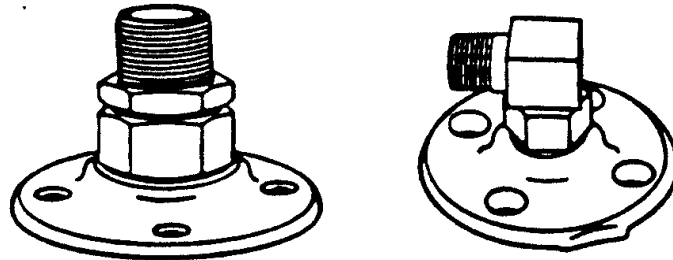
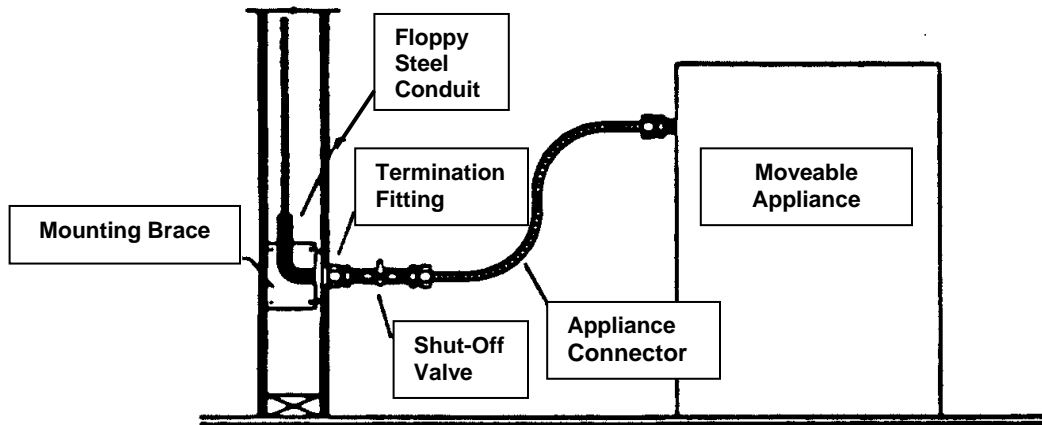

TERMINATION FITTING

3. Connecting fixed appliances (house heaters, water heaters, etc) with CSST is permitted provided.
 - (a) A flange mount termination fitting is secured above the floor or on the outside of a finished wall when encountered. At this point rigid iron pipe should then connect to the appliance. Use of an approved flexible connector is permitted provided a "rigid, iron pipe" exits the appliance and a shut-off valve is provided upstream from the appliance connector. *Note: The CSST connection fitting is not to be considered a union; CSST manufacturers do not recommend frequent disassembly and assembly.*
 - (b) A sediment trap is still required at all fixed appliances.
 - (c) Regarding appliance connections from above, CSST will be permitted to supply a fixed appliance provided the appliance has rigid pipe entering the gas control consisting of an appliance shut-off valve, union, and sediment trap. CSST material must then be secured to the casing of the appliance so as to prevent sagging and / or the chance possibility of a person or object pulling the tubing.

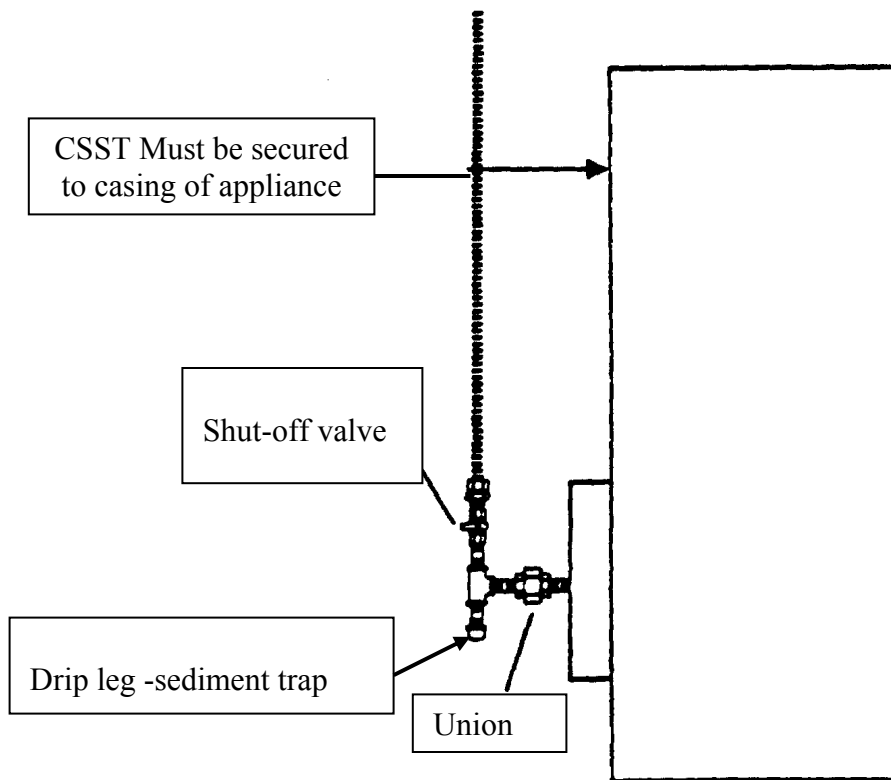

“FIXED” NON-MOVABLE APPLIANCE

4. CSST Supplying Roof-top Equipment
 - (a) CSST is permitted to pass through a roof to supply roof top equipment. PGW code requires a condensate drip whenever piping passes from a heated space to a cold space.
 - (b) CSST will be permitted to run horizontally along the roof.
 - (c) CSST must be installed per manufacturer’s specifications.
 - (d) PGW will still require sediment trap at each appliance.
5. Connecting suspended appliances (Infrared Heaters, etc).
 - (a) CSST will be permitted to connect suspended appliances provided the CSST material remains higher than 7ft from the ground.

- (b) CSST will be permitted to connect to outdoor, suspended appliances provided the exposed CSST does not exceed 3ft in length and remains at least 7ft from the ground.
6. CSST jointing two (2) lengths of hard pipe.
- (a) CSST is permitted to joint two (2) lengths of hard pipe. There is no minimum requirement regarding the length of CSST connecting the separate sections of pipe.
7. CSST installed in concealed locations
- (a) Job-sites or projects considered “new construction” or “total rehabs” should have their workmanship inspected prior to piping test and turn-on order.

G. CSST Installations in Walls

1. Horizontal Runs

- (a) It is preferred that CSST enter a partition wall for vertical runs only. When it is necessary to install CSST horizontally through framing or studding, precautions should be taken to protect CSST from the damage of nails, etc.
- (b) Striker plates should be installed affording protection not less than 3" on each side of the stud material where CSST passes through.
- (c) Any exposed CSST material visible between studding should be sleeved in floppy wound conduit or iron pipe.

NOTE: CSST passing horizontally through metal framing material must be protected where the tubing passes through along the sharp metal edge. Preferred methods of protection should be either a RUBBER or PLASTIC GROMMETS, CHASE BUSHING, SPLIT TUBING, SPIRAL TUBING.

2. Vertical Runs

- (a) CSST installed vertically inside a framed wall shall be protected from damage up to 3" from where CSST passes through "footer" framing or header framing.
- (b) DO NOT secure CSST to framing (wood or metal) with clamps; CSST should be free to move inside the walls and between floors.

- (c) DO NOT position CSST inside the hollow portion of metal framing materials.

H. CSST Located Outdoors

1. All CSST material located outdoors should be sleeved in an approved material both on horizontal and vertical runs. This material must be marked every 10ft stating "NATURAL GAS".
2. CSST material shall not be permitted to be used as a "quick disconnect" or "flexible connector" to an outdoor appliance.

I. Bonding of Fuel Line

1. CSST tubing gas piping systems shall be bonded to the Electrical Services Grounding Electrode System.
2. Bonding shall be accomplished using a bonding clamp positioned around the metallic lock nut of the CSST.
3. The bonding stumper shall not be smaller than 6 AWG copper wire.

SUPPLEMENT

PHILADELPHIA GAS WORKS FIELD SERVICE DEPARTMENT

Ventilation & Combustion Air

All information is referenced from:
International Fuel Gas Code IFGC – 2006
National Fuel Gas Code NFPA 54 – 2006
Local Codes, Policies and Procedures

This information is intended strictly as a guide. For further information and/or variations, refer to your IFGC-2006, your Supervisor or FSD Training

CONFINED SPACE

A 100,000 Btu appliance requires 5,000 cubic feet of space
100,000 Btu *divided by "20" equals* 5,000 cubic feet

Divide "20" into the appliance Btu input rating.

The resulting number is the *minimum* size room required in cubic feet.

If the room size in cubic feet (LxWxH) is less than this number, adequate *make-up air for combustion* is required.

ALL Air From INSIDE Building

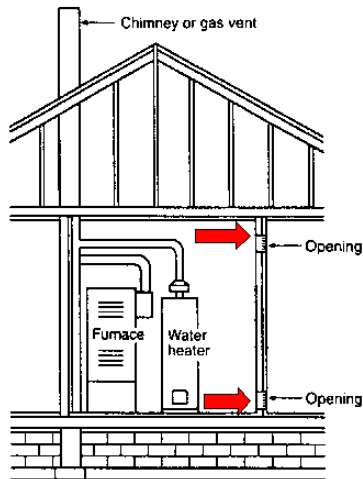

- Two (2) permanent openings, 12” from top and bottom
- Minimum opening 10” x 10”
- Opening dimensions should be determined by Btu input
- One (1) square inch for each 1000 Btu’s

ALL Air From OUTDOORS

Inlet air from “ventilated” crawl space
Outlet air to “ventilated” attic

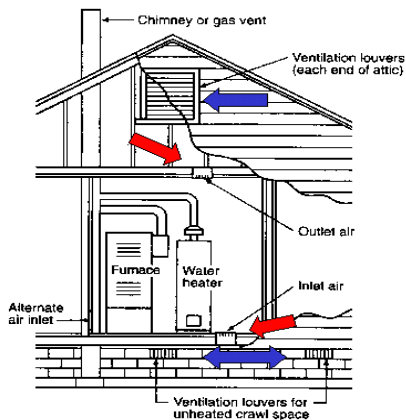

- Vertical ducts to crawl space and attic
- One (1) square inch for each 4000Btu
- Fresh air opening entering crawl space should be minimum 12” from ground

ALL Air From OUTDOORS “Ventilated” Attic ONLY

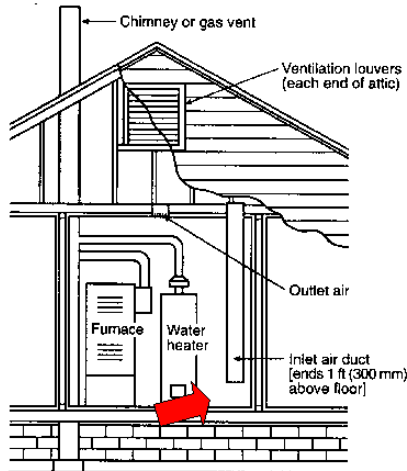

- Two (2) openings to attic
- One (1) square inch for each 4000Btu's
- Fresh air duct from attic should terminate 12" from floor

ALL Air From OUTDOORS SINGLE Combustion Air Opening

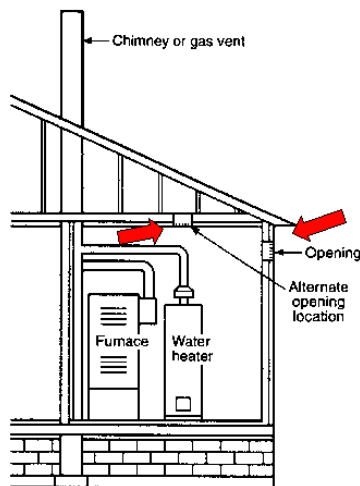

- One (1) permanent opening
- Vertical duct to “ventilated” attic
- Horizontal duct directly outdoors, 12" from ceiling
- One (1) square inch for each 3000Btu's

ALL Air From OUTDOORS

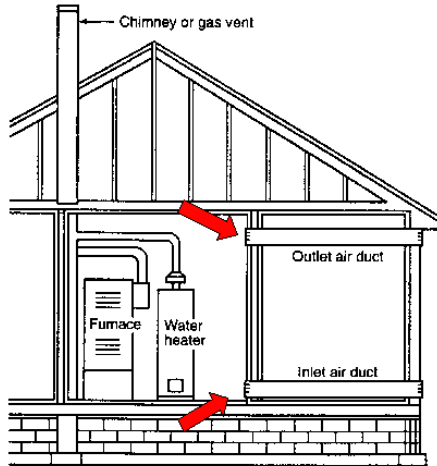

- Two (2) horizontal ducts to outside of building
- Outlet duct 12" from ceiling
- Inlet duct 12" from floor
- One (1) square inch for each 2000 Btu's

Mechanical and Direct Vent Sidewall Terminations

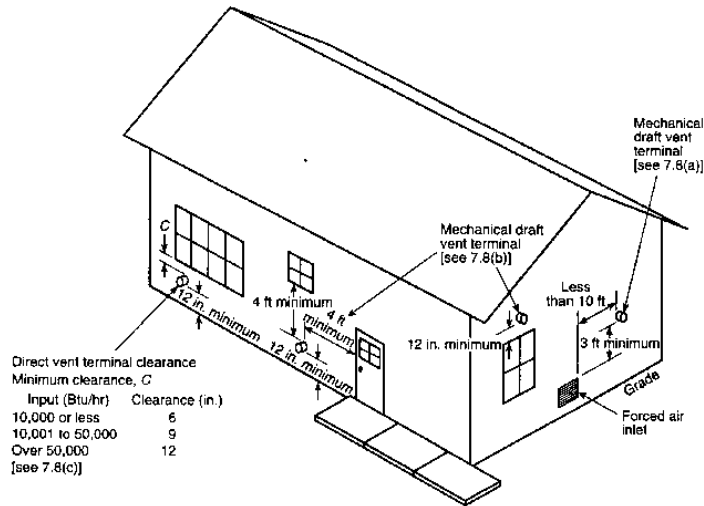

Direct vent terminal clearance	
Minimum clearance, C	
Input (Btu/hr)	Clearance (in.)
10,000 or less	6
10,001 to 50,000	9
Over 50,000	12

[see 7.8(c)]

For SI units: 1 ft = 0.305 m; 1 in. = 25.4 mm;
1 Btu/hr = 0.293 W

ADEQUATE VENTILATION

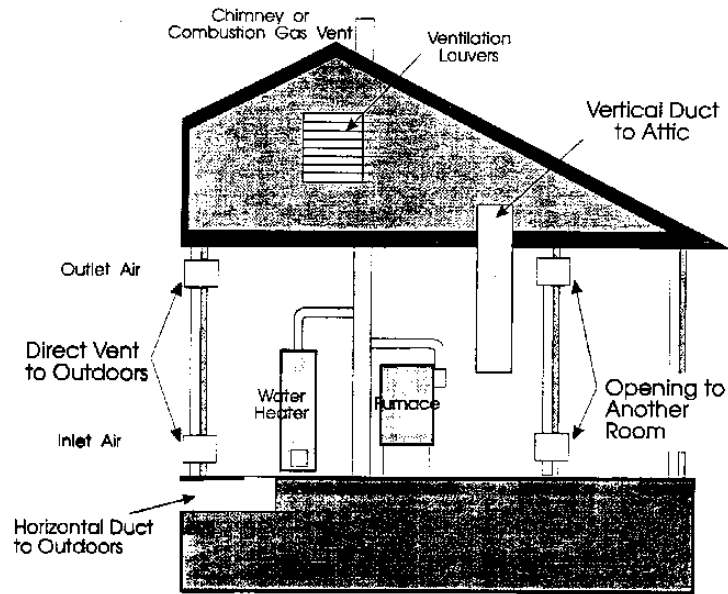

Checklist for Installers and Owners – Commercial & Industrial

PGW Marketing Representative: _____

Phone: _____

STEPS		REFERENCE	DATE	YES	NO
1.	International Fuel Gas Code	Piping and equipment to meet ANSI Z223.1 IFGC 2009			
2.	<i>Obtain PGW Field Services Department's Book "Piping Specifications" 2010</i>	Read & Understand Questions: Call 215-787-5130			
3.	<i>Before installation, Submit Piping Plan to Field Service Department for review.</i> Required on 1500 cfh and above, or any gas booster installation.	List all equipment to be installed, their CFH and pipe sizes with length of run. Contact 215-787-5130 for site pick-up or questions. Or mail to Marketing Rep.			
4.	<i>PGW Distribution Dept. "Specifications on Underground Piping"</i> <i>(If Applicable)</i>	If you Plan to install any type gas piping that are to be buried underground. Contact: 215-684-6384/6691			
5.	<i>PGW witness of Pipe Test</i> <i>(usually 24 Hours notice)</i>	Your Marketing Rep. will schedule test. (equipment should not be connected till pipe test is passed)			
6.	<i>Meter Installation</i> <i>(usually 1 to 3 days after pipe test is passed)</i>	Fuel line connection to be within 3' of meter location.			
7.	<i>Notification of Factory Rep. (If Applicable)</i>	Some equipment requires a "authorized factory representative" for start-up. For warranty purposes.			
8.	<i>Turn-On Gas</i>	All equipment must be installed and ready for Turn-On. Exceptions can be made for heat only during heating season. Locrit valve must be supplied. Call 215-787-5130 for exception.			
9.	<i>Safety Inspection</i>	PGW will perform a safety inspection at time when equipment is placed in operation.			

Check List For Residential Installations

PGW Marketing Representative: _____

Phone: _____

STEPS		REFERENCE	Date:	YES	NO
1.	<i>International Fuel Gas Code</i>	Piping and equipment to meet ANSI Z223.1 IFGC 2009			
2.	<i>Obtain PGW Field Services Department's "Piping Specifications Book - October 2010"</i>	Read & Understand Questions: Call 215-787-5130			
3.	<i>PGW Distribution Dept. "Specifications on Underground Piping"</i> <i>(If Applicable)</i>	If you Plan to install any type gas piping that are to be buried underground. Contact: 215-684-6384 / 6691			
4.	<i>PGW witness of Pipe Test (usually 24 Hours notice) (If Applicable)</i>	Refer to PGW, Field Service Dept. Piping Spec. Table on Test Requirements.			
5.	<i>* Meter Installation</i>	If service is installed, notify your Marketing Rep. to schedule meter installation. Fuel line connection to be within 3' of meter location.			
6.	<i>* Turn-On Gas</i>	Understand all equipment should be ready at time of Turn-On.			
7.	<i>* Safety Inspection</i>	PGW will perform a safety inspection at time when equipment is placed in operation.			

*** PGW will attempt to complete Steps 5 through 7 on the same date.**

NOTES: